



SERVICE IDEAS WORK TOGETHER 2008 CATALOG



EFFECTIVE JANUARY 15, 2008



WORK TOGETHER

For over 60 years, we've come to see that many of life's finest moments happen in much the same way: together. That's why we are passionate about bringing people to the table and have designed our products to do just that. Though all of the products in our catalog have a singular purpose, the best part is - like so many of us - our products work even smarter and accomplish even more when they are put together. If you'd like creative new ways to combine our products and wow your customers, give us a call - because it's not just our products that work together. It's us. We look forward to working with you this year, and are committed to helping you meet your goals, whatever they are. Together.

YOUR PARTNERS,
THE MURRAY FAMILY
& TEAM SERVICE IDEAS

TABLE		GLASS LINED SERVERS		STAINLESS PITCHER	38
BREAD BASKETS	13	ALFI® ALBERGO	29	TEA BALL	36
HOT SOLUTIONS	12	ALFI® BASIC MODERN SERVERS	26	TEA CHEST	34
SUGAR/CREAMER SET	14	ALFI® DAN	29	WATER PITCHER	38
SYRUP BOTTLE - NEW!	14	ALFI® DIANA - NEW!	27		
SYRUP CADDY - NEW!	14	ALFI® HANDY	27	AIRPOTS	
SYRUP SAVER	14	ALFI® JUWEL	29	AIRPOT COVER-UPS	47
TABLE ORGANIZERS - NEW!	13	ALFI® JUWEL SUGAR/CREAMER	29	AIRPOT STANDS	48
THERMO-PLATE™ PLATTERS	10-11	ALFI® KUGEL BALL SERVERS	25	BLACKTIE™ SIGHT GLASS	45
TUSCANY GLASS™ COLLECTION - NEW!	3-9	ALFI® NEAT - NEW!	27	BREWER PACKAGES - NEW!	50
WINE CHILLER - NEW!	13	ALFI® NOMOS	26	COFFEE AND TEA DISPENSER CLEANERS	49
WOOD PLATTER	12	ALFI® OPAL	28	CONDIMENT HOLDERS	49
		ALFI® SAPHIR	28	COMPARTMENT CONDIMENT ORGANIZER NEW!	49
PLASTIC LINED SERVERS		ALFI® TOSCANA	26	DRIP TRAYS - NEW!	47
ECO-SERV™	19	CLASSIC GLASS CARAFE™	31	ECO-AIR® COLORS	42
IDENTIFICATION LABELS STATIC CLING	19	CLASSY™ VACUUM SERVER	31	ECO-AIR® GLASS LINED	42
METALLIC LUSTER™	17	PUSH N' SERV™	30	ECO-AIR® PARTS	43
NEW GENERATION®	16	ULTRA CARAFE	30	ECO-AIR® STAINLESS LINED	42
PUSH BUTTON METALLIC SERVER - NEW!	17	IDENTIFICATION MAGNETS - NEW!	30	ECONOMY STAINLESS	43
SWIRL SERVER - NEW!	18			GRAVITY-SERV™	44
THERMO-SERV® FLIP TOP SERVERS	18	SPECIALTY SERVERS & ACCESSORIES		IDENTIFICATION CHAINS	48
THERMO-SERV® PUSH BUTTON SERVERS	17	ALFI® COFFEE MAKER	32	PREMIUM GLASS LINED	45
TWIST N' SERV™	19	ALFI® COOL BOTTLE	37	ROTO RACK - NEW!	47
CUSTOM CRESTING	18	ALFI® TEEKANNE	33	STEELVAC™ SIGHTGLASS	45
		BREDEMEIJER®	35	STEELVAC™ STAINLESS LINED	46
STAINLESS LINED SERVERS		CERAMIC TEA POT	36	WIRE RACKS	48
ALFI® TOP THERM ALBERGO	21	CERAMIC 'CAST IRON LOOK' TEA POT	34		
ALFI® TOP THERM HOTELLO	21	FIRST AID KITS	39	BUFFET	
ALFI® TOP THERM JUWEL	20	DECANTER	38	BUFFET BOWLS	56
ALFI® TOP THERM OPAL	20	FROTHING PITCHERS	38	INSULATED URNS	57
BREW N' POUR™ STEELVAC™	24	ICE BUCKETS	39	TEA URNS	57
CLASSIC STAINLESS CARAFE	24	ICE TUBE PITCHER	37	THERMAL CONTAINER	55
FLAVORBANDS	22	NON-SLIP TRAY - NEW!	39	TONGS	56
STAINLESS PITCHERS	21	PLASTIC TEAPOT	36	ZE PÉ BEVERAGE DISPENSERS	52
STEELVAC™ PWLA CARAFES	22	SCULPTURED ICE™ PITCHER	37	ZE PÉ CEREAL DISPENSERS	53
STEELVAC™ FVP CARAFES	22	SERVICE IDEA BRICK PRESS	32	ZE PÉ CLOCHE	53
STEELVAC™ SJ CARAFES	23	SERVICE IDEAS TEA POT	33	ZE PÉ SERVING CARTS	54
STEELVAC™ S/S2 CARAFES	23	SERVICE IDEAS COFFEE PRESS	33	ZE PÉ YOGURT	53

SEE PRODUCT INDEX FOR PRICING

PRODUCT + PLACE

TABLE TUSCANY GLASS COLLECTION



TABLE OVER SIXTY YEARS AGO, WE CARRIED OUT THE FIRST SIZZLING PLATE OF FOOD ON OUR PATENTED THERMO-PLATE™ PLATTERS. TABLE SERVICE HAS CONTINUED TO EVOLVE AND FOR EVERY PRODUCT THERE IS A PLACE, EVERY PLACE THERE IS SERVICE IDEAS. WHETHER YOU ARE A CORNER CAFÉ OR A NATIONAL CHAIN, WE HAVE THE RIGHT PRODUCT FOR YOUR PLACE.





800943 - WAVY RIM
BLUE, GRAY, GREEN, WHITE



8009221 - WAVY RIM
BLUE, GRAY, GREEN, WHITE



800343 - STANDARD RIM
BLUE, GRAY, GREEN, WHITE



8003221 - STANDARD RIM
BLUE, GRAY, GREEN, WHITE

LIMITED QUANTITIES IN BLUE.
SPECIAL ORDER BROWN, LAVENDER, PINK.

TUSCANY GLASS™ NUAGE COLLECTION

Colors are swirled into the glass material, no two look alike.

WAVY RIM

- 800943** NUAGE SHINY WAVY RIM (6 EACH)
13" (34 CM)
COLORS AVAILABLE: WHITE, GRAY, GREEN, BLUE
- 8009221** NUAGE SATIN WAVY RIM
13" (34 CM)
COLORS AVAILABLE: WHITE, GRAY, GREEN, BLUE

STANDARD RIM

- 800343** NUAGE SHINY STANDARD RIM (6 EACH)
12.5" (32 CM)
COLORS AVAILABLE: WHITE, GRAY, GREEN, BLUE
- 8003221** NUAGE SATIN STANDARD RIM (6 EACH)
12.5" (32 CM)
COLORS AVAILABLE: WHITE, GRAY, GREEN, BLUE

ESPRESSO

- 7083CL** CLEAR SHINY ESPRESSO 3 OZ CUP (6 EACH)
2.5" X 3.5" X 2.5" (6.4 CM X 8.9 CM X 6.4 CM)
- 708343** NUAGE SHINY ESPRESSO 3 OZ CUP (6 EACH)
2.5" X 3.5" X 2.5" (6.4 CM X 8.9 CM X 6.4 CM)
COLORS AVAILABLE: WHITE, BROWN
- 7085CL** CLEAR SHINY ESPRESSO SAUCER (6 EACH)
4.5" (11.3 CM)
- 708543** NUAGE SHINY ESPRESSO SAUCER (6 EACH)
4.5" (11.3 CM)
COLORS AVAILABLE: WHITE, BROWN

CAPUCCINO **NEW**

- 7084CL** CLEAR SHINY CAPUCCINO 5 OZ CUP (6 EACH)
4.5" X 3.5" X 2.5" (11.4 CM X 6 CM X 6.4 CM)
- 708443** NUAGE SHINY CAPUCCINO 5 OZ CUP (6 EACH)
4.5" X 3.5" X 2.5" (11.4 CM X 6 CM X 6.4 CM)
COLORS AVAILABLE: WHITE, BROWN
- 7086CL** CLEAR SHINY CAPUCCINO SAUCER (6 EACH)
5.5" (13.3 CM)
- 708643** NUAGE SHINY CAPUCCINO SAUCER (6 EACH)
5.5" (13.3 CM)
COLORS AVAILABLE: WHITE, BROWN



708343 (CUP), 708543 (SAUCER)
708443 (CUP), 7084643 (SAUCER)
WHITE, CLEAR, BROWN

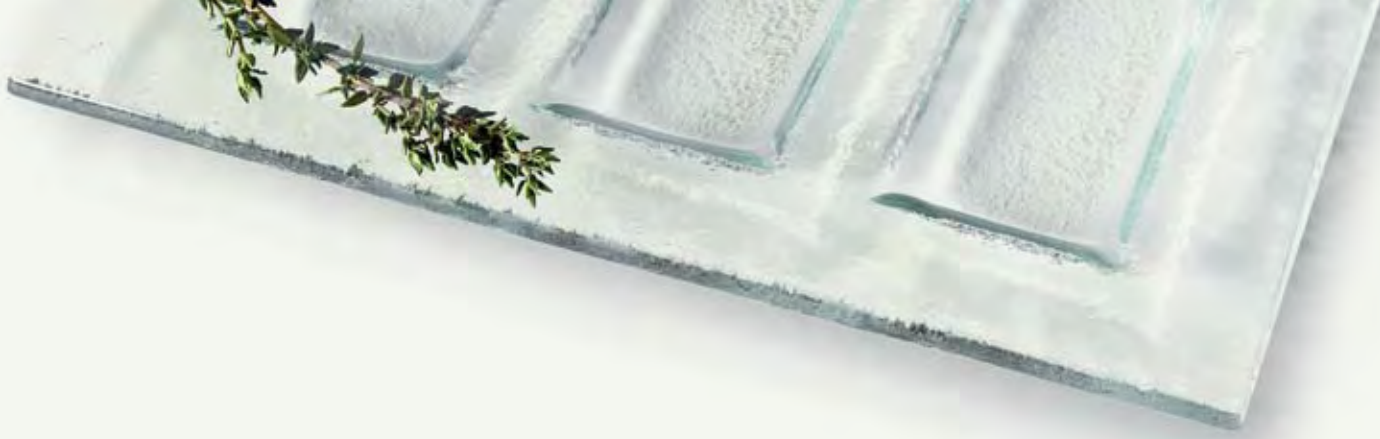

9515 SQUARE
CLEAR W/GREEN TINT

9504 SQUARE
CLEAR W/GREEN TINT



9521 3 COMPARTMENT SMALL
CLEAR W/GREEN TINT



9520 3 COMPARTMENT LARGE
CLEAR W/GREEN TINT

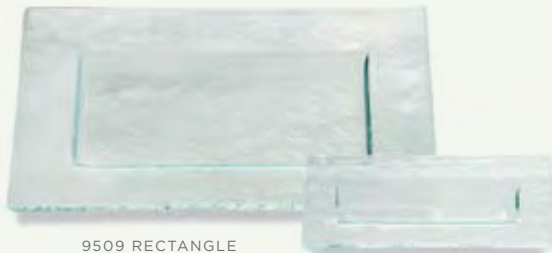

9509 RECTANGLE
CLEAR W/ GREEN TINT

9506 RECTANGLE
CLEAR W/ GREEN TINT

**TUSCANY GLASS™ ECO-LINE COLLECTION -
LOWER PRICING**

1/4" glass. Produced in Montelupo Fiorentino, Italy, one of the most productive areas for glass items since the early 1500's. Produced in the appropriate thickness for hotel and restaurant use. **Subject to 8 week lead time on special and volume orders.** Made in Italy. **Dishwasher safe.**

Case Pack: as noted.

TRIANGLES

- 9522 TRIANGLE (12 EACH)
8.25" (21 CM)
- 9511 TRIANGLE (12 EACH)
11" (27.5 CM)

SQUARES

- 9515 SQUARE (12 EACH)
4.75" (12 CM)
 - 9502 SQUARE (6 EACH)
9.875" (25 CM)
 - 9504 SQUARE (6 EACH)
12.25" (31 CM)
- COLOR AVAILABLE: CLEAR WITH GREEN TINT

COMPARTMENTS

- 9521 COMPARTMENT (6 EACH)
9.875" X 6" (25 CM X 15 CM)
- 9520 COMPARTMENT (6 EACH)
15.75" X 7.5" (39.3 CM X 19 CM)

RECTANGLES

- 9506 RECTANGLE (12 EACH)
7.875" X 4" (19.6 CM X 10.1 CM)
 - 9507 RECTANGLE (6 EACH)
9.875" X 6" (25 CM X 15 CM)
 - 9509 RECTANGLE (6 EACH)
13.75" X 8.25" (35 CM X 21 CM)
- COLOR AVAILABLE: CLEAR WITH GREEN TINT

9522 TRIANGLE
CLEAR W/ GREEN TINT





7114CL
RAIN

7138CL
RAIN



7135CL
RAIN

7226CL
RAIN



7212CL
RAIN

7216CL
RAIN

7217CL
RAIN



7273CL
RAIN

7270CL
RAIN

TUSCANY GLASS™ RAIN COLLECTION

Subject to 8 week lead time on special and volume orders. Made in Italy. Dishwasher safe.

Case Pack: as noted.

RECTANGLES

- 7114CL RECTANGLE RAIN (6 EACH)
11.75" X 7.8" (29.8 CM X 19.8 CM)
 - 7138CL RECTANGLE RAIN (6 EACH)
9.75" X 6.25" (24.8 CM X 15.9 CM)
 - 7139CL RECTANGLE RAIN (6 EACH)
7.5" X 5" (19.1 CM X 12.7 CM)
 - 7140CL RECTANGLE RAIN (12 EACH)
6" X 4" (15.2 CM X 10.2 CM)
- COLORS AVAILABLE: CLEAR

OVALS

- 7134CL OVAL RAIN (12 EACH)
9.5" X 7.5" (24.1 CM X 19.1 CM)
 - 7135CL OVAL RAIN (12 EACH)
12" X 10.25" (30.5 CM X 26 CM)
- COLORS AVAILABLE: CLEAR

ROUNDS

- 7225CL ROUND RAIN (12 EACH)
10.6" (26.9 CM)
 - 7226CL ROUND RAIN (12 EACH)
8.25" (21 CM)
- COLORS AVAILABLE: CLEAR

RAIN DROPS

- 7211CL RAIN DROP (6 EACH)
9" X 8" (22.9 CM X 20.3 CM)
 - 7212CL RAIN DROP (6 EACH)
11.25" X 9.75" (38.6 CM X 24.8 CM)
 - 7215CL RAIN DROP (6 EACH)
8.8" X 7.8" (22.4 CM X 19.8 CM)
 - 7216CL RAIN DROP (6 EACH)
7.5" X 6.5" (19.1 CM X 16.5 CM)
 - 7217CL RAIN DROP (12 EACH)
3.25" X 3" (8.3 CM X 7.6 CM)
- COLORS AVAILABLE: CLEAR

SQUARES

- 7270CL SQUARE COUPE RAIN (12 EACH)
8.6" (21.8 CM)
 - 7272CL SQUARE COUPE RAIN (12 EACH)
10.6" (26.9 CM)
 - 7273CL SQUARE COUPE RAIN (6 EACH)
12.8" (32.5 CM)
- COLORS AVAILABLE: CLEAR



TUSCANY GLASS™ COLLECTION **NEW**

1/4" glass. Produced in Montelupo Fiorentino, Italy, one of the most productive areas for glass items since the early 1500's. Colors are in the glass material. Produced in the appropriate thickness for hotel and restaurant use. **Subject to 8 week lead time on special and volume orders.** Made in Italy. **Dishwasher safe.**

Case Pack: as noted.



7245IV
IVORY
RICCIOLO

7247IV
IVORY
RICCIOLO

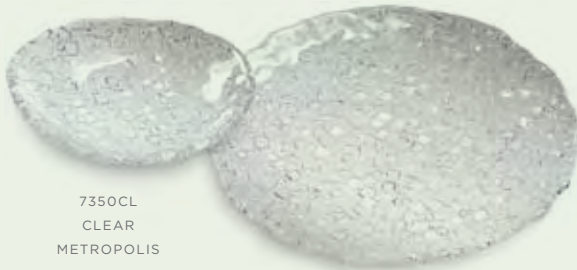

7350CL
CLEAR
METROPOLIS

7348CL
CLEAR
METROPOLIS

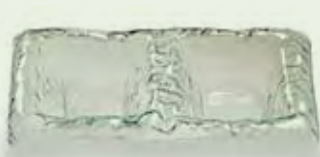

1802CL
CLEAR W/GREEN TINT
NUVOLA



1803 CL
CLEAR W/GREEN TINT
NUVOLO



1406CL
CLEAR W/GREEN TINT
SCOMPARTI

- RICCIOLO (6 EACH)**
7245IV RICCIOLO 8.25" (21 CM)
7246IV RICCIOLO 10.6" (27 CM)
7247IV RICCIOLO 12.5" (32 CM)

- METROPOLIS**
OVALS
7350CL METROPOLIS OVAL (6 EACH) 9.5" X 7.5" (24 CM X 49 CM)
ROUNDS
7344CL METROPOLIS ROUND (12 EACH) 6.3" (16 CM)
7348CL METROPOLIS ROUND (6 EACH) 14.6" (38 CM)
SQUARE
7367CL METROPOLIS SQUARE (12 EACH) 5.5" (14 CM)
CENTERPIECE
7358CL METROPOLIS CENTERPIECE (6 EACH) 11.8" X 1.8" (30 CM X 4.5 CM)
TUMBLER
7355CL METROPOLIS TUMBLER (6 EACH) 10 OZ 4" (10 CM)

- IMPILABILI**
1200CL 12" X 9.5" (6 EACH) (30 CM X 24 CM)
1201CL 10.25" X 7.5" (6 EACH) (26 CM X 19 CM)
2100CL 17.75" X 13.75" (1 EACH) (45 CM X 35 CM)

- NUVOLA (6 EACH)**
1801CL ANTIPASTA 3 COMPARTMENT 16" X 6" (41 CM X 15 CM)
 (NOT SHOWN)
1802CL ANTIPASTA 2 COMPARTMENT 11.5" X 6" (29 CM X 15 CM)
1803CL ANTIPASTA 4 COMPARTMENT 11" X 11" (28 CM X 28 CM)

- SCOMPARTI (6 EACH)**
1406CL QUADRO 5 COMPARTMENT 11.75" X 1.25" (29 CM X 3 CM)



1201CL
1200CL
2100CL

IMPILABILI
CLEAR W/GREEN TINT



8001
BLUE, CLEAR



8003
BLUE, CLEAR



8880/43WH
SHINY

8880CL
SHINY

8880/221WH
SHINY



8130201SA
SATIN



8123CL
SHINY

8123BLU3
BLUE

8123301CL
SATIN

TUSCANY GLASS™ COLLECTION

LINED

8001 COLORS LINED (6 EACH)
12.5" (32 CM)
COLORS AVAILABLE: CLEAR (CLR), BLUE (BLU)

PEBBLED

8003 COLORS PEBBLED (6 EACH)
12.5" (32 CM)
COLORS AVAILABLE: CLEAR (CLR), BLUE (BLU)

CAKE STANDS

8880 FOOTED CAKE (1 EACH)
10.5" X 3.5" (27 CM X 9 CM)
COLORS AVAILABLE: CLEAR, WHITE

TRIANGLES

8130201SA TRIANGLE SATIN (6 EACH)
12.5" (32 CM)

FRUTTI MARE

8123CL COUPE (6 EACH)
12.5" (32 CM)
8123BLU3 COUPE BLUE (6 EACH)
12.5" (32 CM)
8123301CL COUPE CLEAR (6 EACH)
12.5" (32 CM)
COLORS AVAILABLE: SHINY, SATIN, BLUE



8143CL
SHINY

TUSCANY GLASS™ COLLECTION

1/4" glass. Produced in Montelupo Fiorentino, Italy, one of the most productive areas for glass items since the early 1500's. Colors are in the glass material. Produced in the appropriate thickness for hotel and restaurant use. **Subject to 8 week lead time on special and volume orders.** Made in Italy. Dishwasher safe.

Case Pack: as noted.

UNIVERSAL SQUARES

- 8143CL UNIVERSAL SQUARE SHINY (6 EACH)
12" (31 CM)
COLORS AVAILABLE: CLEAR

GOURMET

- 8950202SA GOURMET BOWL SATIN (6 EACH)
4" X 12.5" (10 CM X 32 CM)
- 8949202SA GOURMET BOWL SATIN (6 EACH)
2.375" X 11.5" (6 CM X 29 CM)
- 8948202SA GOURMET BOWL SATIN (6 EACH)
2.375" X 7.5" (6 CM X 19 CM)
- 8951202CL GOURMET PLATE SATIN (6 EACH)
12.5" (32 CM)
COLORS AVAILABLE: SATIN

FISH EYE

- 8866CL FISH EYE (6 EACH)
12" X 7.5" (30.5 CM X 19.1 CM)
- 8789CL FISH EYE (6 EACH)
19.5" X 9.5" (49.5 CM X 24.1 CM)
COLORS AVAILABLE: CLEAR



8948202/8949202SA
SATIN

8950202SA
SATIN



8789CL
CLEAR



ABOUT LUX

OFFERED BY SERVICE IDEAS, INC.

TUSCANY GLASS

Glossy transparencies, colored reflections, elegant manufacturing. Beauty in a dish to be used everyday.

Since 1967 Lux has produced handcraft glass, creating original pieces for table service. Following the most up-to-date market requests and offering a wide range of shapes, models and colors.

Since 2005, Lux offers even more. The new 31.000 sqm building can house up to 12.000 pallets for more efficient warehousing, giving us the possibility to raise our customer service.

Let the Tuscany glass collection set the mood with unique table presentations that can be enjoyed everyday. Lux sets the table with charger plates, drinking glasses, pizza plates and sushi plates. The beauty of the glass overlapping makes the table the star for any event.

Let Lux emphasize every moment with bright colors, chic nuances and charming design.

The Tuscany glass collection is from the Montelupo Fiorentino, Italy, one of the most productive areas for glass items since the early 1500's, and is 1/4" thick, the appropriate thickness for hotel and restaurant use. It features colors that are in the glass material and won't fade or wear off.

Service Ideas, Inc. offers a new selection in the rain pattern as well as the Eco-Line, satin, nuage and others. All items are in convenient case packs.





OT11
BL / BLACK



RO117
BL / BLACK



RT10 WITH OYSTER INSET
BL / BLACK



RT7
BL / BLACK

THERMO-PLATE™ PLATTERS



Plate constructed from 304 bright annealed, .048 gauge stainless, optional aluminum (RO117), the holder from polyester. Stackable. Optional escargot (RT7/701) and oyster (RT10) insets for rounds.

Hand wash the plate, the holder is dishwasher safe.

Case pack: 12 each, 6 each (FP3), (Completes & Parts).

ORIGINALS

OT11C	SMALL ORIGINAL HOLDER/INSERT PLATE: 6.5" X 11" (16.5 CM X 27.9 CM) HOLDER: 8" X 12.5" (20.3 CM X 30.5 CM)
LO12C	LARGE ORIGINAL HOLDER/INSERT PLATE: 8" X 12.5" (20.3 CM X 31.8 CM) HOLDER: 9.5" X 14" (24.1 CM X 35.6 CM)

PARTS	OT11BL	HOLDER FOR OT11SS
	OT11SS	11" STAINLESS INSERT
	LO12BL	HOLDER FOR LO12SS
	LO12SS	12" STAINLESS INSERT
	LO125SS	6"(HALF) STAINLESS INSERT (ORDER 2 FOR EACH HOLDER)

OVALS

RO128C	OVAL HOLDER/INSERT PLATE: 11.75" X 7.75" (29.8 CM X 19.7 CM) HOLDER: 13.75" X 10" (34.9 CM X 25.4 CM)
RO117AC	HANDLE HOLDER/ALUMINUM INSERT PLATE: 11.75" X 7.25" (29.8 CM X 18 CM) HOLDER: 13.75" X 8.5" (34.9 CM X 21.6 CM)
RO117C	HANDLE HOLDER/STAINLESS STEEL PLATE: 11.75" X 7.25" (29.8 CM X 18 CM) HOLDER: 13.75" X 8.5" (34.9 CM X 21.6 CM)

PARTS	RO128BL	OVAL HOLDER FOR RO128SS
	RO128SS	OVAL 11.75" STAINLESS INSERT
	RO117BL	HANDLE HOLDER FOR RO117SS OR RO117AL
	FPI/RO117AL	HANDLE ALUMINUM INSERT FOR RO117
	FPI/RO117SS	HANDLE STAINLESS INSERT FOR RO117

ROUNDS

RT10C	10" ROUND HOLDER/INSERT PLATE: 10" (25.4 CM) HOLDER: 12" (30.5 CM)
RT1025C	10.25" HOLDER/INSERT PLATE: 10.25" (26 CM) HOLDER: 12.25" (31.1 CM)
RT7C	7" SLOPING HOLDER/INSERT PLATE: 7.5" (19.1 CM) HOLDER: 9.5" (24.1 CM)
RT701C	7" HOLDER/INSERT PLATE: 7.5" (19.1 CM) HOLDER: 9.5" (24.1 CM)

PARTS	RT10BL	10" HOLDER FOR RT10SS
	RT10SS	10" STAINLESS STEEL INSERT
	RTO10SS	10" STAINLESS STEEL OYSTER INSERT
	RT1025BL	10.25" HOLDER FOR RT1025SS
	RT1025SS	10.25" STAINLESS STEEL INSERT
	RT7BL	7" SLOPING RIM HOLDER FOR RT7SS
	RT7SS	7" STAINLESS STEEL INSERT
	RT701BL	7" STRAIGHT RIM HOLDER FOR RT7SS
	RTE7SS	7" STAINLESS STEEL ESCARGOT INSERT

THERMO-PLATE™ PLATTERS



Plate constructed from 304 bright annealed, .048 gauge stainless, optional aluminum (FP1), the holder from polyester or phenolic (FP3). Stackable.

Hand wash the plate, the holder is dishwasher safe.

Case pack: 12 each, 6 each (FP3), (Completes & Parts).



FP1 (SMALL)
BL / BLACK

FISH	
FP1AC	SMALL FISH HOLDER/ALUMINUM INSERT PLATE: 11.75" X 7.25" (29.8 CM X 18.4 CM) HOLDER: 14.25" X 9.75" (36.2 CM X 24.8 CM)
FP1C	SMALL FISH HOLDER/STAINLESS INSERT PLATE: 11.75" X 7.25" (29.8 CM X 18.4 CM) HOLDER: 14.25" X 9.75" (36.2 CM X 24.8 CM)
FP3C	SUPER FISH HOLDER/STAINLESS INSERT PLATE: 14" X 8.5" (35.6 CM X 21.6 CM) HOLDER: 21" X 13.75" (53.3 CM X 34.9 CM)
PARTS	
FP1	SM FISH HOLDER FOR FP1/RO117AL OR FP1/RO117SS
FP1/RO117AL	HANDLE ALUMINUM INSERT FOR FP1
FP1/RO117SS	HANDLE STAINLESS INSERT FOR FP1
FP3	SUPER FISH HOLDER FOR FP3SS
FP3SS	SUPER STAINLESS FISH INSERT

THERMO-PLATE™ PLATTERS

Service Ideas, Inc's original Thermo-Plate™ Platter technology keeps hot foods hot and cold foods cold. Platters are ideal for steaks, pasta, seafood, poultry, sandwiches, omelets and ethnic presentations. Use the divided half plates for combinations of hot and cold presentations, or choose a round plate for specialties like escargot, oysters and deviled eggs. Lightweight polyester holders provide strength and durability and can greatly reduce replacement costs of broken china. Diagram below describes how the Service Ideas, Inc. Thermo-Plate™ Platter works.

CARE/HANDLING

To prevent warping, stainless and aluminum plates should never be subjected to an open flame. Instead, they should be heated only in an oven or on a griddle up to 350° F. Wood products cannot be washed with water. Wipe wood with a wood-friendly cleaner or a barely damp cloth.

CRESTING

Custom Cresting available with camera ready art. Increase awareness and reinforce your brand with Service Ideas, Inc's Custom Cresting program. Lead time with camera ready artwork is four weeks. \$7.00 list per color, 36 minimum.

CUSTOM COLORS

Custom Colors are available. 300 minimum.

HOW THERMO-PLATE™ PLATTERS WORK:

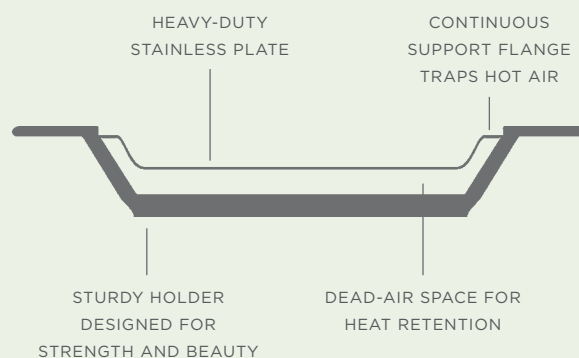

CRESTING



STACKABLE



CUSTOM COLORS

500° F or below skillet placed on plate

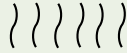

Inner core traps heat at 200° F

HS13 CUTAWAY

Plate is cool to the touch!



CUSTOM COLORS AVAILABLE UPON REQUEST

HOT SOLUTIONS™ PLATTER

Nothing takes a steaming skillet from stovetop to tabletop like the HOT SOLUTIONS platter. It tolerates temperatures up to 500° F, without transferring the heat—and frames your skillet in the color of your choice.

FEATURES:

- The lightweight insulation protects the table from heat transfer.
- Side rails protect hands from hot skillet.
- The edge is rolled for an upscale look and easy handling.
- The platter fits any standard fajita skillet and includes room for the skillet to expand when heated.
- A notched foot holds the skillet steady and allows for draining when washing.
- Platters are stackable.
- Custom colors, shapes, and molded logos are available.



HS13 + SK10CI
BLACK

HS13 + SK10CIH
BLACK

HOT SOLUTIONS™ PLATTER/SKILLET



MADE IN THE USA



1 YEAR WARRANTY ON INSULATION

Constructed from plastic with polyester blend insulation. Innovative insulation tolerates temperatures to 500° F while preventing heat transfer. Custom colors = 96 - 239 each \$250 color match charge. 240 each, no extra charge. **For longer life recommend low temperature dishwasher.**

Case pack: 6 each.

HS13BL	HOT SOLUTIONS BLACK PLATTER HOLDER 12.5" X 9" X 1.5" (31.5 CM X 23 CM X 4.8 CM)
SK10CI	CAST IRON SKILLET W/OUT HANDLE 7.25" X 10" X 0.75" (18.5 CM X 25 CM X 1.9 CM)
SK10CIH	CAST IRON SKILLET WITH HANDLE 7.25" X 10" X 0.75" (18.5 CM X 25 CM X 1.9 CM)



SK107BHC
BIRCHWOOD

WOOD PLATTER/SKILLET



MADE IN THE USA

Skillet constructed from sandcast aluminum, holder made from wood. Real wood holders, lightweight skillet. **Hand wash.**

Case pack: 12 each (Completes & Parts)

SK107BHC	BIRCHWOOD HOLDER W/ SANDCAST SKILLET SKILLET: 7.25" X 9.5" (18.4 CM X 24.1 CM) WITH 5" (12.7 CM) HANDLE, HOLDER: 9" X 12" (22.9 CM X 30.5 CM)
PARTS	SK107BH BIRCHWOOD HOLDER FOR SK107 SK107CA SANDCAST FAJITA SKILLET WITH HANDLE



BKOV
STAINLESS

BKRD7
BKRO
STAINLESS



BKTA
STAINLESS



BKWI
STAINLESS



035501000
TRANSPARENT CRYSTAL
WITH STAINLESS



0355051000
BLUE TINTED ACRYLIC
WITH STAINLESS



WC1
BRUSHED STAINLESS

BREAD BASKETS

Constructed from a lightweight stainless steel. Available in convenient sizes. Constructed from chromed metal wire, BKTA combination of 38 and 60 gauge, BKWI 50 gauge. **Hand wash.**
Case pack: 1 each.

BKOV	LARGE OVAL 11" X 7.5" (27.9 CM X 19.1 CM)
BKRD7	7" ROUND 7" (17.8 CM)
BKRO	9" ROUND 9.5" (24.1 CM)
BKTA	TALL BREAD BASKET 10" X 11" X 12" (25.4 CM X 27.9 CM X 30.5 CM)
BKWI	WIDE BREAD BASKET 13" X 7.5" X 4" (33 CM X 19.1 CM X 10.2 CM)

CRYSTAL WINE CHILLER **NEW**

Constructed from double walled acrylic and stainless steel. Features integrated cooling liquid. Holds 4" diameter bottle. **Hand wash.**

Case pack: 1 each.

0355010000	TRANSPARENT CRYSTAL WINE CHILLER 5.13 X 8" (13 CM X 18.7 CM)
0355051000	BLUE TINTED CRYSTAL WINE CHILLER 5.13 X 8" (13 CM X 18.7 CM)

STAINLESS WINE CHILLER

Constructed from stainless steel. Features double-wall construction that eliminates condensation. Fits 4" diameter bottles. **Hand wash.**

Case pack: 1 each.

WC1	WINE CHILLER 7.75" X 4.75" (19.7 CM X 12.1 CM)
------------	---

TABLE ORGANIZER **NEW**

Constructed from stainless steel. Choose from a variety of options to create one for your needs. All parts sold separately. **Hand wash.**
Case pack: 1 each sets/6 each parts.



STOCFCR
STAINLESS



STOSPSH
STAINLESS



STOCPCSR
STAINLESS

STOCFCR	CRESTED 4 PACK COFFEE CONDIMENT SET WITH HOLDER 5.25" X 2" (13.3 CM X 5.1 CM), 6.25" X 2" (15.9 CM X 5.1 CM)
STOH4	4 CONDIMENT STAINLESS STEEL HOLDER
STC7VANILLA	VANILLA CRESTED STAINLESS 7 HOLE TOP
STCMESHNUTM	NUTMEG CRESTED STAINLESS MESH TOP
STCMULTICINN	CINNAMON CRESTED STAINLESS MULTI-HOLE TOP
STCTEARCOCOA	COCOA CRESTED STAINLESS TEAR-DROP TOP
STOCFF	PLAIN 4 PACK COFFEE CONDIMENT SET WITH HOLDER 5.25" X 2" (13.3 CM X 5.1 CM), 6.25" X 2" (15.9 CM X 5.1 CM)
STOH4	4 CONDIMENT STAINLESS STEEL HOLDER
STC7	PLAIN STAINLESS 7 HOLE TOP
STCMESH	PLAIN STAINLESS MESH TOP
STCMULTI	PLAIN STAINLESS MULTI-HOLE TOP
STCTEAR	PLAIN STAINLESS TEAR-DROP TOP
STOCPCSR	CRESTED 2 PACK COFFEE CONDIMENT SET WITH HOLDER 5.25" X 2" (13.3 CM X 5.1 CM), 6.25" X 2" (15.9 CM X 5.1 CM)
STOH2	2 CONDIMENT STAINLESS STEEL HOLDER
STCMESHPSUGR	POWDERED SUGAR CRESTED STAINLESS MESH TOP
STCMULTICINN	CINNAMON CRESTED STAINLESS MULTI-HOLE TOP
STOSPSH	SALT AND PEPPER SET WITH HOLDER 5.25" X 2" (13.3 CM X 5.1 CM), 6.25" X 2" (15.9 CM X 5.1 CM)
STOH2	2 CONDIMENT STAINLESS STEEL HOLDER
STC7	PLAIN STAINLESS 7 HOLE TOP
STC3	PLAIN STAINLESS 3 HOLE TOP



SY916
AL / ALMOND



SY916
BL / BLACK



SY916
WH / WHITE



SZ10
BL / BLACK



SZ10RED
RED / RED COVER

SZ10YL
YL / YELLOW COVER



WORK TOGETHER IDEA;
COORDINATE YOUR LOOK



SZS4
STAINLESS

SZC4
COPPER



SSC85
BRUSHED STAINLESS
W/ CHROME

SYRUP SAVER™



1 YEAR WARRANTY



SAN plastic construction. Flow restricted pour. **Dishwasher safe.**

Case pack: 6 each.

Specify color when ordering.

SY916 .5 LITER (16 OZ)
5.75" X 3" (13.3 CM X 7.6 CM)

PARTS SYL SY DISPENSER LID FOR SY916 (CASE PACK 12)
SYJ916 SY DISPENSER JAR FOR SY916 (CASE PACK 12)

SYRUP BOTTLE NEW



1 YEAR WARRANTY



Polycarbonate plastic construction. Optional embossed syrup flavors on the lid. Can heat in syrup warmer to 140 degrees.

Dishwasher safe.

Case pack: 12 each.

SZ10BLBU .3 LITER (10 OZ) BLUEBERRY SYRUP DISPENSER
2.75" X 4.5" X 5" (7 CM X 11.4 CM X 12.7 CM)

SZ10BLBP .3 LITER (10 OZ) BUTTER PECAN SYRUP DISPENSER
2.75" X 4.5" X 5" (7 CM X 11.4 CM X 12.7 CM)

SZ10BLBY .3 LITER (10 OZ) BOYSENBERRY SYRUP DISPENSER
2.75" X 4.5" X 5" (7 CM X 11.4 CM X 12.7 CM)

SZ10BLST .3 LITER (10 OZ) STRAWBERRY SYRUP DISPENSER
2.75" X 4.5" X 5" (7 CM X 11.4 CM X 12.7 CM)

SZ10xx .3 LITER (10 OZ) PLAIN SYRUP DISPENSER
2.75" X 4.5" X 5" (7 CM X 11.4 CM X 12.7 CM)

PARTS SZLxx REPLACEMENT LID FOR SZ10xx,
STATE FLAVOR WHEN ORDERING. (CASE PACK 12)
SZJ10CL REPLACEMENT JAR FOR SZ10BL
(CASE PACK 12)

SYRUP CADDY NEW



Stainless and plastic construction. Holds four SZ10 syrup bottles. Available in stainless or copper. **Dishwasher safe.**

Case pack: 4 each.

SZS4 4 SYRUP STAINLESS CADDY
12.25" X 3.5" X 3.25" (31.1 CM X 8.9 CM X 8.3 CM)

SZC4 4 SYRUP COPPER CADDY
12.25" X 3.5" X 3.25" (31.1 CM X 8.9 CM X 8.3 CM)

SUGAR/CREAMER SET

Constructed from 18/8 stainless steel with a chrome plated plastic lid. Features a space saving, stylish design. **Dishwasher safe.**

Case pack: 1 each/master case 24 each complete sets/6 each creamer only.

SSC85 8.5 OZ SUGAR/CREAMER SET
4.75" X 2.5" (12.1 CM X 6.7 CM)

SC85 8.5 OZ CREAMER
4.75" X 2.5" (12.1 CM X 6.7 CM)

SS85 8.5 OZ SUGAR
4.75" X 2.5" (12.1 CM X 6.7 CM)

PARTS SLC85 CREAMER REPLACEMENT LID
SLS85 SUGAR REPLACEMENT LID
SC85GAS CREAMER GASKET



SERVERS AN INTIMATE TABLE FOR TWO. A BOUNCING BISTRO OF TWO HUNDRED. A MOM-AND-POP COUNTER WITH TOO MANY SPECIALTIES TO COUNT. WHATEVER THE STAGE, WE'LL HELP YOU SET IT. OUR INSULATED SERVERS KEEP COFFEE HOT FOR HOURS. OUR ICE TUBE PITCHERS KEEP BEVERAGES COOLED AND UNDILUTED. FROM MORNING TO MIDNIGHT AND EVERY EVENT IN BETWEEN, WE'VE GOT THE SERVERS YOU NEED.



PLASTIC-LINED SERVERS

HANDLING

For optimal retention, remove or flip open lid and preheat server with warm water. Empty contents and refill with hot beverage. Secure lid closure. Server will maintain optimal retention no longer than 2-3 hours. Varying factors that effect temperature are content levels, topping off, open lids. Servers should not be heated in a microwave.

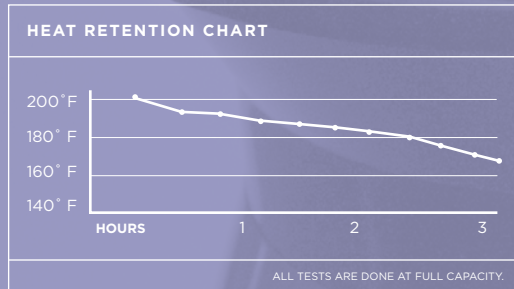

CLEANING

For optimal care, servers should be hand washed with mild detergents. Where noted, servers constructed with an ultrasonic weld are dishwasher safe in most commercial dishwashers where temperatures do not rise above 185 F. However, please check MSDS forms of detergents since some do interact unfavorably with plastics. To clean push-button lids, depress button and flush water through. Push button lids are not dishwasher safe. Never clean plastic servers with vinegar as it will be absorbed by the material and leave a vinegar taste.

STORAGE

Store in a cool, dry place away from any heat sources.

TROUBLE SHOOTING

Cracks in body are usually from a chemical reaction and extended use. Bulging to the inner liner or exterior body may be caused by extreme heat conditions. Welded lids may separate over time and are able to be purchased separately. Gapping may occur between joints of the product as a result of wear and tear over an extended time. Servers should never be heated in a microwave.

WARRANTY

Products noted with symbol are warranted against manufacturer defects for specified years. As a manufacturer of fine products, Service Ideas, Inc. is interested in knowing about any problems you may experience. We will work with you individually to determine if the problem is caused by a manufacturer's defect.

PLASTIC SERVERS

- Durable, impact-resistant ABS outer shell resists cracking, chipping and peeling
- Double wall body
- Environmentally safe polyurethane foam insulation
- Inner liner heat, impact and stain resistant
- Reinforced handle for added safety
- Completely sealed, all sonic welded body

PANTONE MATCHING SYSTEM

The Pantone Matching System (PMS) allows you to know the specific color of your servers so you can coordinate with color schemes of other pieces or decor. The following numbers represent the colors of the New Generation line:

Almond	726C	Country Blue	652C
Burgundy	209C	Forest Green	343C
Brown	476C	Gray	429C
Cobalt Blue	276C	Mauve	694C



NG501
ST/COB / STONEWARE
W/ COUNTRY BLUE
.6L



NG101
MV / MAUVE
1L



NG101
CBT \ COBALT BLUE
1L



NG101
FG \ FOREST GREEN
1L



NG101
BU / BURGUNDY
1L



NG101
AL / ALMOND
1L



NG101
GR / GRAY
1L



NG101
WH / WHITE
1L



NG101
BL / BLACK
1L

ALL COLORS STOCKED IN 1 LITER SIZE.
SPECIAL ORDER 20 OZ AND 2 LITER SIZES MAY INCUR
2-4 WEEK LEAD TIME AND AN 84 PC MINIMUM.
CALL FOR CURRENT INVENTORY.

NEW GENERATION™



2-3 HOUR TEMPERATURE RETENTION



2 YEAR WARRANTY



Durable ABS plastic construction with foam insulation. Optional decaf, Take-A-Part or Brew N' Pour™ lids available. Optional custom crestring available. Lid with Decaf imprint may be substituted by adding "D" to model number. Specify color when ordering. **Dishwasher safe, for longer life recommend hand wash.**

Case pack: 6 each.

NG501	.6 LITER (20 OZ.)
	8" X 4.5" (20.3 CM X 11.4 CM)
NG101	1 LITER (33.8 OZ.)
	9.25" X 5" (23.5 CM X 12.7 CM)
NG421	2 LITER (67.6 OZ.)
	11.25" X 6" (28.6 CM X 15.2 CM)

PARTS	DESCRIPTION
NGL	NSF TAKE A-PART LID (CASE PACK 12)
NGLW	WELDED PUSH BUTTON LID (CASE PACK 12)
BTL	BREW-THRU LID (CASE PACK 12)
NGLGAS	GASKET FOR NGL (CASE PACK 12)

Application Suggestion 2-3 hour retention required, heavy-duty usage, self-service, may be left on tables, ideal for chains, family restaurants, country clubs.



ML101MSSBL
SSBL / STAINLESS
W/ BLACK



ML101MCPBL
CPBL / COPPER
W/ BLACK



ML501
.6 LITER
CH/BL CHROME
W/BLACK



ML101
1 LITER
CH/BL CHROME
W/BLACK



ML315
1.5L
CH/BL CHROME
W/BLACK



PB501
SB / SILVER
W/ BLACK



PB101
CB / COPPER
W/ BLACK



PB421
KB / GOLD
W/ BLACK



PB
ST/BR / STONEWARE
W/ BROWN



PB
BL / BLACK

ALL COLORS STOCKED IN 1 LITER SIZE.
SPECIAL ORDER 20 OZ AND 2 LITER SIZES MAY INCUR
2-4 WEEK LEAD TIME AND AN 84 PC MINIMUM.
CALL FOR CURRENT INVENTORY.

PUSH BUTTON METALLIC SERVER NEW



2-3 HOUR TEMPERATURE RETENTION

Durable metal body with protective coating, plastic liner and foam insulation. Classic design with safety push-button lid. Optional decaf, Take-A-Part or Brew N' Pour™ lids available. Optional custom crestring available. Lid with Decaf imprint may be substituted by adding "D" to model number. **Hand wash.**

Case pack: 6 each.

ML501M	.6 LITER (20 OZ) 6" X 4" X 8" (15.2 CM X 10.2 CM X 20.3 CM)
ML101M	1 LITER (33.8 OZ) 6.5" X 5" X 9.5" (16.5 CM X 12.7 CM X 24.1 CM)

PARTS NGLWBL BLACK WELDED PUSH BUTTON LID (CASE PACK 12)
NGLGAS GASKET FOR NGLW (CASE PACK 12)

METALLIC LUSTER™



2-3 HOUR TEMPERATURE RETENTION

Plastic construction with foam insulation. Actual chrome powder finish. Lid with Decaf imprint may be substituted by adding "D" to model number. **Dishwasher safe, for longer life recommend hand wash.**

Case pack: 6 each.

ML501	.6 LITER (20 OZ) 8" X 4.5" (20.3 CM X 11.4 CM)
ML101	1 LITER (33.8 OZ) 9.25" X 5" (23.5 CM X 12.7 CM)
ML315	1.5 LITER (50.7 OZ) 11.75" X 5" (29.8 CM X 12.7 CM)

PARTS NGLWBL BLACK WELDED PUSH BUTTON LID (CASE PACK 12)
NGLGAS GASKET FOR NGLW (CASE PACK 12)

Application suggestion 2-3 hour retention required, medium-duty service, self service, limited restaurants, business & industry.

THERMO-SERV® PUSH BUTTON SERVERS



2-3 HOUR TEMPERATURE RETENTION

Durable ABS plastic shell with foam insulation. Classic design with safety push-button lid. Optional decaf, Take-A-Part or Brew N' Pour™ lids available. Optional custom crestring available. Lid with Decaf imprint may be substituted by adding "D" to model number. Specify color when ordering. **Dishwasher safe, for longer life recommend hand wash.**

Case pack: 6 each.

PB501	.6 LITER (20 OZ) 8" X 4.5" (20.3 CM X 11.4 CM)
PB101	1 LITER (33.8 OZ) 9.25" X 5" (23.5 CM X 12.7 CM)
PB421	2 LITER (67.6 OZ) 11.25" X 6" (28.6 CM X 15.2 CM)

NOTE: AVAILABLE BY SPECIAL ORDER, 45 DAY LEAD TIME,
120 MINIMUM - CALL FOR PRICING.

PB315 1.5 LITER (50.7 OZ)

PARTS NGLW WELDED PUSH BUTTON LID (CASE PACK 12)
NGLGAS GASKET FOR NGLW (CASE PACK 12)

Application suggestion 2-3 hour retention required, heavy-duty usage, self-service, may be left on tables, ideal for chains, family restaurants, country clubs.



TS501
BL / BLACK



TS101
CB / COPPER
W/ BLACK



TS411
KB / GOLD
W/ BLACK



CUSTOM CRESTING
EXAMPLE



SSS20
BL / BLACK
.6L



SSS42
GM / GUN METAL



SSS42
WH / WHITE



SSS64
MO / MOCHA

ALL COLORS AVAILABLE IN ALL 3 SIZES.

THERMO-SERV® FLIP TOP SERVERS

2-3 HOUR TEMPERATURE RETENTION 2 YEAR WARRANTY MADE IN THE USA

The original plastic insulated server since 1956. Durable ABS shell with foam insulation. Classic design. Optional custom crestring available. Lid with Decaf imprint may be substituted by adding "D" to model number, or add "OR" for all orange lid. **Dishwasher safe, for longer life recommend hand wash.**

Case pack: 6 each.

Specify color when ordering.

TS501	.6 LITER (20 OZ) 7.5" X 4.5" (19.1 CM X 11.4 CM)
TS101	1 LITER (33.8 OZ) 9" X 5" (22.9 CM X 12.7 CM)
TS411	2 LITER (67.6 OZ) 10.75" X 6" (27.3 CM X 15.2 CM)

PARTS	TSL1 FLIP TOP LID FOR TS501/TS101 (CASE PACK 12)
	TSL2 FLIP TOP LID FOR TS411 (CASE PACK 12)

Application suggestion 2-3 hour retention required, wait person service, banquets, water pitcher.

CUSTOM CRESTING

Available with camera ready art. Increase awareness and reinforce your brand with Service Ideas' Custom Cresting program. We print your logo right on plastic servers, turning them into advertisements themselves. Lead time with camera ready artwork is four weeks.

\$7.00 LIST PER COLOR, PER HIT; 36 MINIMUM.

SWIRL SERVERS NEW

2-3 HOUR TEMPERATURE RETENTION

Plastic exterior with foam insulation. Snap on decaf, tea or coffee indicators. Specify color when ordering. **Handwash.**

Case Pack: as noted. **Sold in case packs only.**

SSS20	.6 LITER (20 OZ.) (12 EACH) 6.5" X 4.75" X 8" (16.5 CM X 12.1 CM X 20.3 CM)
SSS42	1.3 LITER (42 OZ.) (12 EACH) 8" X 5.5" X 10" (20.3 CM X 14 CM X 25.4 CM)
SSS64	1.9 LITER (64 OZ.) (6 EACH) 8.75" X 6.5" X 11.25" (22.2 CM X 16.5 CM X 28.6 CM)

PARTS	SSSL20 REPLACEMENT LID FOR SSS20 (12 EACH)
	SSSL42 REPLACEMENT LID FOR SSS42 (12 EACH)
	SSSL64 REPLACEMENT LID FOR SSS60 (6 EACH)
	SSSFTVAR INDICATOR TAB - COFFEE, TEA, DECAF



BOTH COLORS AVAILABLE IN BOTH SIZES.



BOTH COLORS AVAILABLE IN ALL 3 SIZES.



ECO-SERV®



Plastic exterior with foam insulation. Snap on decaf indicator. Specify color when ordering. **Dishwasher safe, for longer life recommend hand wash. Lids NOT dishwasher safe.**

Case Pack: 12 each. **Sold in case packs only.**

ECO6	.6 LITER (20 OZ.) 7" X 5" X 6.5" (17.8 CM X 12.7 CM X 16.5 CM)
ECO13	1.3 LITER (44 OZ.) 9.75" X 5" X 7" (24.8 CM X 12.7 CM X 17.8 CM)

PARTS	ECL LID FOR ECO6/ECO13 (CASE PACK 12)
	FT10R DECAF INDICATOR TAB (CASE PACK 12)

Application Suggestion High quantity needed, 2-3 hour retention required, light service usage, never recommended for any application associated with the healthcare industry.

TWIST N' SERV™



Plastic construction with foam insulation. Push button lid. Specify color when ordering. Twist Top special order - lead time 60 days.

Hand wash.

Case Pack: 12 each. **Sold in case packs only.**

TWIST LID	
TNS20	.5 LITER (17 OZ.) 7.25" X 3.5" X 5.25" (18.4 CM X 8.9 CM X 13.3 CM)
TNS40	1.2 LITER (40.1 OZ.) 9.5" X 4.5" X 7" (24.1 CM X 11.3 CM X 17.8 CM)
TNS60	1.8 LITER (60.8 OZ.) 11.5" X 5.25" X 7.5" (28.9 CM X 13 CM X 19.1 CM)

PUSH BUTTON	
TNSPB20	.5 LITER (17 OZ.) 7.25" X 3.5" X 5.25" (18.4 CM X 8.9 CM X 13.3 CM)
TNSPB40	1.2 LITER (40.1 OZ.) 9.5" X 4.5" X 7" (24.1 CM X 11.3 CM X 17.8 CM)
TNSPB60	1.8 LITER (60.8 OZ.) 11.5" X 5.25" X 7.5" (28.9 CM X 13 CM X 19.1 CM)

PARTS	TNSL20 TWIST LID FOR TNS20 (CASE PACK 12)
	TNSL40 TWIST LID FOR TNS40 (CASE PACK 12)
	TNSL60 TWIST LID FOR TNS60 (CASE PACK 12)
	TNSPBL20 PUSH BUTTON LID FOR TNSPB20 (CASE PACK 12)
	TNSPBL40 PUSH BUTTON LID FOR TNSPB40 (CASE PACK 12)
	TNSPBL60 PUSH BUTTON LID FOR TNSPB60 (CASE PACK 12)

IDENTIFICATION LABELS

Static cling. Clean, easy way to identify contents. **Made in USA.** Wipe with damp cloth.

Case pack: 1 sheet/20 labels.

SC1VPA	VARIETY SHEET: MILK, 2% (2 EACH), SKIM MILK, CREAM, HOT WATER, COFFEE, DECAF, REGULAR, BREAKFAST BLEND, COLOMBIAN, FRENCH ROAST, GOURMET BLEND, HOUSE BLEND, ALMOND, AMARETTO, FRENCH VANILLA, HAZELNUT, IRISH CREAM, MOCHA
SC1CA	COLD SHEET: CREAM, MILK, HALF & HALF, 2% (5 EACH OF 4=20)
SC1HA	HOT SHEET: HOT WATER, REGULAR, DECAF, HOUSE (5 EACH OF 4=20)

STAINLESS-LINED SERVERS

HANDLING

To obtain optimal retention, remove lid and preheat with warm water. Empty water, refill with hot beverage and replace lid.

HEAT RETENTION CHART

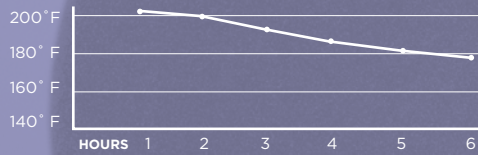

ALL TESTS ARE DONE AT FULL CAPACITY.

CLEANING

Exterior-wipe with a soft, damp cloth and follow with dry cloth. Interior-clean with warm water and mild detergent. Rinse with hot water. Never submerge server in water or place in a dishwasher. Lids may be rinsed with hot water.

STORAGE

Product is best stored in a cool, dry place away from all heat sources.

TROUBLE SHOOTING

If your server is not holding heat and the above procedures are followed, it may be a result of a broken vacuum. A strong impact and dishwashing may contribute to the vacuum being compromised.

WARRANTY

As a manufacturer of fine products, Service Ideas, Inc. is interested in knowing about any problems you may experience. We will work with you individually to determine if the problem is caused by a manufacturer's defect.

STAINLESS FACTS

Stainless steel is an alloy that starts with basic iron with up to 8 alloys added, depending on the quality. The major alloys in stainless steel are chromium and nickel. The chromium provides rust, corrosion resistance and durability. Nickel provides additional rust resistance, strength, and high polishing characteristics.

The numbers 18/0 indicates 18 percent chromium and 0 percent nickel. 18/8 indicates 18 percent chromium and 8 percent nickel. 18/10 indicates 18 percent chromium and 10 percent nickel. The more percent of nickel, the higher the grade and the higher the costs. While 18/0 is not necessarily unsatisfactory, it is not considered corrosion resistant.



577
CHROME
1.5L AVAILABLE
JUWEL

ALFI® JUWEL TOP THERM



4-6 HOUR TEMPERATURE RETENTION

Brass with polished chrome finish exterior and stainless interior. Handmade and crafted in a traditional design with an unbreakable stainless liner and stopper lid. Matching creamer/sugar on page 27. Optional glass liner, page 29. **Hand wash/do not submerge.**

Case pack: 1 each.

57715 1.5 LITER (50.7 OZ)
11.25" X 5.5" (28.6 CM X 14 CM)

AVAILABLE BY SPECIAL ORDER—CALL FOR PRICING. (8 WEEK LEAD TIME)

5774 .4 LITER (13.5 OZ)

5778 .8 LITER (27 OZ)

PARTS 571LID LID AND HINGE
572GAS LID GASKET
STOPPER STOPPER FOR LID .8 LITER—2 LITER
STOPPER2 STOPPER FOR LID .4 LITER—.8 LITER



697
CHROME
1.5L AVAILABLE
OPAL

ALFI® OPAL TOP THERM



4-6 HOUR TEMPERATURE RETENTION

Brass with polished chrome finish exterior and stainless interior with vacuum insulation. Handmade and polished, crafted in traditional design with an unbreakable stainless liner and stopper lid. Optional glass liner, page 28. **Hand wash/do not submerge.**

Case pack: 1 each.

69715 1.5 LITER (50.7 OZ)
12" X 5.75" (30.5 CM X 14.6 CM)

AVAILABLE BY SPECIAL ORDER—CALL FOR PRICING. (8 WEEK LEAD TIME)

6974 .4 LITER (13.5 OZ)

6978 .8 LITER (27 OZ)

PARTS 571LID LID AND HINGE
572GAS LID GASKET
STOPPER STOPPER FOR LID
STOPPER2 STOPPER FOR LID .4 LITER—.8 LITER

0767000060
CHROME
.6L0767000100
CHROME
1L0767000150
CHROME
1.5L0767000200
CHROME
2L

ALL 4 SIZES IN CHROME FINISH.

ALFI® ALBERGO TOP THERM



Stainless exterior with stainless interior and vacuum insulation. Features an unbreakable stainless liner with a push-button lid. Optional Glass liner, page 29. **Hand wash/do not submerge.**

Case pack: 1 each.

0767000060	.6 LITER (20 OZ) 7" X 5" (18.2 CM X 13 CM)
0767000100	1 LITER (33.8 OZ) 8.75" X 5" (22.3 CM X 13 CM)
0767000150	1.5 LITER (50.7 OZ) 9.5" X 5.25" (24 CM X 13.7 CM)
0767000200	2 LITER (67.6 OZ) 11" X 5.25" (28 CM X 13.7 CM)

PARTS 767LID LID

55730
STAINLESS
.3L55760
STAINLESS
.6L55710
STAINLESS
1L55715
STAINLESS
1.5L

ALL 4 SIZES IN POLISHED STAINLESS FINISH.

ALFI® HOTELLO TOP THERM



Stainless steel exterior and interior with vacuum insulation. Features dishwasher safe vacuum, unbreakable liner and weighted lid. **Dishwasher safe.**

Case pack: 1 each.

55730	.3 LITER (10 OZ) 5.5" X 5" X 5.75" (14 CM X 12.7 CM X 14.6 CM)
55760	.6 LITER (20 OZ) 6.5" X 5" X 5.75" (16.5 CM X 12.7 CM X 14.6 CM)
55710	1 LITER (33.8 OZ) 8" X 5" X 6" (20.3 CM X 12.7 CM X 15.2 CM)
55715	1.5 LITER (50.7 OZ) 10.25" X 5" X 6" (25.7 CM X 12.7 CM X 15.2 CM)

WP3
.3LWP6
.6LWP1
1LWP15
1.5LWP20
2LSA / BRUSHED STAINLESS
CH / POLISHED STAINLESS

ALL 5 SIZES AVAILABLE IN BOTH FINISHES.

STAINLESS PITCHERS



Stainless steel exterior and interior with foam insulation. Features double-wall insulation that virtually eliminates condensation and helps prevent denting. Specify finish when ordering. **Hand wash/do not submerge.**

Case pack: 1 each/master 12 (2 liter 8 each).

WP3	.3 LITER (10 OZ) 7" X 4.25" X 4.5" (17.8 CM X 10.5 CM X 11.4 CM)
WP6	.6 LITER (20 OZ) 8.25" X 4.25" X 4.5" (21 CM X 10.8 CM X 11.4 CM)
WP1	1 LITER (33.8 OZ) 8.5" X 4.5" X 5.25" (21.6 CM X 11.4 CM X 13.3 CM)
WP15	1.5 LITER (50.7 OZ) 10.5" X 5" X 5.25" (26.7 CM X 12.7 CM X 13.3 CM)
WP20	2 LITER (67.6 OZ) 11.25" X 5.5" X 6.5" (28.3 CM X 13.7 CM X 16.5 CM)

Application Suggestions 2-3 hour retention required. Great for cold beverages and banquet service.



PWLA061
STAINLESS
.6L



PWLA121
STAINLESS
1.2L



PWLA161
STAINLESS
1.6L



PWLA201
STAINLESS
2L

ALL 4 SIZES AVAILABLE IN STAINLESS FINISH.

PWL STEELVAC™ CARAFE

4-6 HOUR TEMPERATURE RETENTION 

Lightweight stainless steel exterior and interior with superior vacuum insulation. Features a stylish design and take apart push-button lid. Lid with orange trigger for decaf may be substituted by adding "D". NSF approved. **Hand wash.**

Case pack: 6 each.

PWLA061	.6 LITER (20 OZ) 4.75" X 6" X 6.5" (12.1 CM X 15.2 CM X 16.5 CM)
PWLA121	1.2 LITER (40.6 OZ) 4" X 5" X 7.75" (17.8 CM X 12.7 CM X 19.7 CM)
PWLA161	1.6 LITER (54 OZ) 6.75" X 5" X 9.75" (17.8 CM X 12.7 CM X 24.8 CM)
PWLA201	2 LITER (67.6 OZ) 6.75" X 5" X 11.75" (17.2 CM X 12.7 CM X 29.8 CM)

PARTS	PWLBL PUSH-BUTTON BLACK LID FOR PWL (CASE PACK 6)
	PWLBLD PUSH-BUTTON DECAF LID FOR PWL (CASE PACK 6)

FVP STEELVAC™ CARAFE

4-6 HOUR TEMPERATURE RETENTION

Stainless steel exterior and interior with vacuum insulation. Features an unbreakable liner, push-button lid, optional Brew N' Pour™ or decaf lid available. Lid with orange trigger for decaf may be substituted by adding "D" or "B" for Brew N Pour Lid. after model number. **Hand wash/do not submerge.**

Case pack: 6 each.



FVP12
STAINLESS
1.2L



FVP15
STAINLESS
1.5L



FVP20
STAINLESS
2L

ALL 3 SIZES AVAILABLE IN STAINLESS FINISH.

	FVP
FVP12	1.2 LITER (40.6 OZ) 8.5" X 5.5" (21.6 CM X 14.3 CM)
FVP15	1.5 LITER (50.7 OZ) 9" X 5.5" (22.9 CM X 14.3 CM)
FVP20	2 LITER (67.6 OZ) 10.75" X 5.5" (27.3 CM X 14.3 CM)

PARTS	FVPL PUSH-BUTTON BLACK LID FOR FVP (CASE PACK 6)
	FVPLOR PUSH-BUTTON BLACK LID WITH ORANGE TRIGGER FOR FVP (CASE PACK 6)
	FVPBTL BREW N' POUR™ BLACK LID FOR FVP (CASE PACK 6)
	FVPBTLOR BREW N' POUR™ ORANGE LID FOR FVP (CASE PACK 6)

FLAVORBANDS

Rubber band identifiers are recommended for 4" or smaller diameter servers, models: S, S2S, TSV & SJ on page 22.

Case pack: Sold in pack of 6 only. Variety pack 1 of each flavor.

FBCREAM	FLAVORBAND CREAM 6 PACK
FBDECAF	FLAVORBAND DECAF 6 PACK
FBHALF&HALF	FLAVORBAND HALF & HALF 6 PACK
FBHOTWATER	FLAVORBAND HOT WATER 6 PACK
FBREGULAR	FLAVORBAND REGULAR 6 PACK
FBSKIM	FLAVORBAND SKIM 6 PACK
FBTEA	FLAVORBAND TEA 6 PACK
FBVARIETY	FLAVORBAND VARIETY 7 PACK
FB COLD	FLAVORBAND COLD VARIETY PACK (2 EACH OF SKIM, H&H, CREAM)

Custom printing available. 500 minimum. \$75 net set-up charge.



FB
FLAVORBANDS



SJ60SS
STAINLESS
.6L



SJ10SS
STAINLESS
1L



SJB20SS
STAINLESS
2L



BREW THRU LID
"B"

ALL 3 SIZES AVAILABLE IN STAINLESS FINISH.

SJ STEELVAC™ CARAFE



Stainless steel exterior and interior with vacuum insulation. Features an unbreakable liner, push-button or Brew N' Pour lid. Lid with orange trigger for decaf may be substituted by adding "D" or "B" for Brew N Pour Lid. **Hand wash/do not submerge.**

Case pack: 6 each.

SJ PUSH BUTTON LID

SJ60SS	.6 LITER (20 OZ) 7.5" X 4.25" X 6.25" (19.1 CM X 10.5 CM X 15.9 CM)
SJ10SS	1 LITER (33.8 OZ) 10.5" X 3.5" X 6" (26.7 CM X 8.9 CM X 15.2 CM)
SJ20SS	2 LITER (67.6 OZ) 12.25" X 4.75" X 7.75" (31.1 CM X 12.1 CM X 19.2 CM)

PARTS	SJL	STEELVAC™ BLACK LID FOR SJ (CASE PACK 6)
	SJLOR	STEELVAC™ DECAF LID FOR SJ (CASE PACK 6)
	SJBTL	STEELVAC™ BREW N' POUR™ LID FOR SJ (CASE PACK 6)
	SJBTLOR	STEELVAC™ BREW N' POUR™ DECAF LID FOR SJ (CASE PACK 6)

S/S2 STEELVAC™ CARAFES



Stainless steel or plastic exterior with stainless interior and vacuum insulation. Features an unbreakable liner, slender style with or without pedestal base and a twist lid. Lid for decaf may be substituted by adding "D" after model number. **Hand wash/do not submerge.**

Case pack: 6 each.



SW70
WHITE
.7L



SB100
BLACK
1L



SS100
STAINLESS
1L

BOTH SIZES AVAILABLE IN 3 FINISHES.



S2S100
STAINLESS
1L



SS100
WITH A CREST
(1 LITER ONLY)



S2S100
WITH A CREST
(1 LITER ONLY)

BOTH SIZES AVAILABLE IN STAINLESS FINISH.

WITH BASE

SB70	BLACK .7 LITER (24 OZ) 9.25" X 4.25" (23.5 CM X 10.8 CM)
SB100	BLACK 1 LITER (33.8 OZ) 11.5" X 4.25" (29.2 CM X 10.8 CM)
SS70	STAINLESS .7 LITER (24 OZ) 9.25" X 4.25" (23.5 CM X 10.8 CM)
SS100	STAINLESS 1 LITER (33.8 OZ) 11.5" X 4.25" (29.2 CM X 10.8 CM)
SS100CRX	STAINLESS 1 LITER (33.8 OZ) - SPECIFY HALF & HALF, SKIM, WHOLE MILK 11.5" X 4.25" (29.2 CM X 10.8 CM)
SW70	WHITE .7 LITER (24 OZ) 9.25" X 4.25" (23.5 CM X 10.8 CM)
SW100	WHITE 1 LITER (33.8 OZ) 11.5" X 4.25" (29.2 CM X 10.8 CM)

WITHOUT BASE

S2S70	STAINLESS .7 LITER (24 OZ) 9" X 3.5" (22.9 CM X 8.9 CM)
S2S100	STAINLESS 1 LITER (33.8 OZ) 11.5" X 3.5" (29.2 CM X 8.9 CM)
S2S100CRX	STAINLESS 1 LITER (33.8 OZ) - SPECIFY 2%, HALF & HALF, SKIM MILK 11.5" X 3.5" (29.2 CM X 8.9 CM)

PARTS	SSLID	STEELVAC™ BLACK LID FOR S, S2 (CASE PACK 6)
	SSLIDOR	STEELVAC™ ORANGE LID FOR S, S2 (CASE PACK 6)



WORK TOGETHER IDEA; COORDINATE YOUR LOOK WITH SSA AIRPOTS ON PG.46



BNP19
STAINLESS W/ BLACK
1.9L

BREW N' POUR™ STEELVAC™ CARAFE

4-6 HOUR TEMPERATURE RETENTION

Stainless steel exterior and interior with vacuum insulation. Interchangeable Brew N' Pour™ decaf lid option. Insulation saves electricity. Lid for decaf may be substituted by adding "OR" after model number. **Hand wash/do not submerge.**

Case pack: 6 each.

BNP19 1.9 LITER (64.2 OZ)
6.5" X 7" X 9" (15.9 CM X 17.8 CM X 22.9 CM)

PARTS BNPL BLACK LID (CASE PACK 6)
BNPLOR ORANGE LID (CASE PACK 6)

Unplug the heat plate of the coffee maker and use the following formula to figure out how much it will save you: 1) Check the wattage of the machine. Ex. 200. 2) Multiply wattage by the number of hours your appliance is in use. Ex. 200 x 16hrs/day = 3,200. 3) Divide by 1000 to get Kilowatt hours. Ex. 3,200 / 1,000 = 3.2 KWH. 4) Check your local Kilowatt hourly rate. Ex. Clark County (Las Vegas), is 5.73 cents per KWH. Multiply your KWH by the local rate. 3.2 KWH x .0573 = .18 cents/day. So you save \$65/year, per warmer, which pays for the server.



CGCS060
SS / BRUSHED
STAINLESS W/ BLACK

CGCS101
CP / COPPER
W/ BROWN

BOTH SIZES AVAILABLE IN BOTH FINISHES.

CLASSIC STAINLESS CARAFE™

4-6 HOUR TEMPERATURE RETENTION

Durable metal exterior with stainless vacuum insulation. Features a virtually dripless spout with 1/8" turn stopper top, tilt to pour. Specify color when ordering. Lid for decaf may be substituted by adding "D" after model number. Optional glass liner page 31. **Hand wash/do not submerge.**

Case pack: 6 each.

Case pack: 6 each.

CGCS060 .6 LITER (20 OZ)
8.5" X 4.75" X 6.25" (21.6 CM X 12.1 CM X 15.9 CM)
CGCS10 1 LITER (33.8 OZ)
10" X 4.5" X 6.25" (25.4 CM X 17.8 CM X 12.1 CM)

PARTS CGRL6SS .6 LITER STAINLESS LINER
CGRL1SS 1 LITER STAINLESS LINER
CGSTOP1 BLACK STOPPER LID (CASE PACK 6)
CGSTOP2 BROWN STOPPER LID (CASE PACK 6)
CGSTOPOR ORANGE STOPPER LID (CASE PACK 6)

DON'T FORGET YOUR CLEANER!

Keep your product looking great.



12632
PAGE 49

GLASS-LINED SERVERS

HANDLING

For optimal retention, remove lid and preheat server with warm water. Empty water and refill with hot beverage. Server will retain optimal retention for 8+ hours.

HEAT RETENTION CHART



CLEANING

Service Ideas, Inc. recommends that all products with vacuum insulation be hand washed. Exterior: Wipe with a soft, damp cloth, follow with a dry cloth. Interior: Clean with luke warm water and mild detergent and rinse with hot water. Never submerge in water, place in a dishwasher, use a brush that may scratch glass liner or use harsh chemical detergents.

STORAGE

Best if stored in a cool, dry place away from any heat sources. Trouble shooting: Moisture between the outer shell and bottom plate or leaking, in most cases is a result of server being immersed in water or liner not secure within body. Liner may be adjusted by tightening bottom plug.

WARRANTY

As a manufacturer of fine products, Service Ideas, Inc. is interested in knowing about any problems you may experience. We will work with you individually to determine if the problem is caused by a manufacturer's defect.



115/165
E / BLACK



115/165
KC / COBALT BLUE



115/165
PA / WHITE



115/165
PP / ANTHRACITE
GRAY



165/115
SV / SILVER



0175 052 094
COBALT BLUE



0175 970 094
COGNAC



0175 033 094
LAVA RED



0175 971 094
ORANGE



0175 010 094
TRANSPARENT

ALFI® KUGEL BALL SERVERS



Polypropylene or acrylic exterior with glass interior and vacuum insulation. Available with twist or push-button lid. Specify color when ordering. **Hand wash/do not submerge.**

Case pack: 1 each.

TWIST LID

115 .9 LITER (30.4 OZ)
8" X 5" (20.3 CM X 12.7 CM)

PUSH-BUTTON LID

165 .9 LITER (30.4 OZ)
8" X 5" (20.3 CM X 12.7 CM)

TRANSPARENT

0175 .9 LITER (30.4 OZ)
8" X 5" (20.3 CM X 12.7 CM)

PARTS	105L	GLASS LINER
	FBL	TWIST LID
	FBTL	PUSH BUTTON LID
	FBSL	TRANSPARENT LID



0915020100
BLACK



0915026100
SILVER



0915053100
LIGHT BLUE



0915051100
COBALT BLUE



865
010 / TRANSPARENT



865
PB / LAVA RED



865
PC / AZURE BLUE



865
PP / ANTHRACITE



1265010100
010 / WHITE
.75L



1265020100
020 / BLACK
.75L



1265030100
030 / RED
.75L



1265050100
050 / BLUE
.75L

ALFI® TOSCANA

8 HOUR TEMPERATURE RETENTION

Acrylic exterior with glass interior and vacuum insulation. Features a twist-top lid. Specify color when ordering. **Hand wash/do not submerge.**

Case pack: 1 each.

0915 1 LITER (33.8 OZ)
8" X 6" (20.3 CM X 15.2 CM)

PARTS 0915999100 GLASS LINER
9103xxx059 PUSH BUTTON LID

ALFI® BASIC MODERN SERVERS

8 HOUR TEMPERATURE RETENTION

Acrylic exterior with glass interior and vacuum insulation. Features a twist-top lid. Specify color when ordering. **Hand wash/do not submerge.**

Case pack: 1 each.

865 .9 LITER (30.4 OZ)
8" X 6" (20.3 CM X 15.2 CM)

PARTS 865L GLASS LINER
BL BASIC MODERN LID

ALFI® NOMOS

8 HOUR TEMPERATURE RETENTION

Plastic exterior with a glass liner. Features a screw top lid. **Hand wash/do not submerge.**

Case pack: 1 each.

1265xxx100 .75 LITER (25.5 OZ)
6.7" X 4.1" X 12.4" (17 CM X 10.5 CM X 31.5 CM)

PARTS 0125999100 REPLACEMENT GLASS LINER
9103020056 REPLACEMENT BLACK LID



HANDY.6
BL / BLACK
.6L



HANDY1
WH / WHITE
1L

BOTH SIZES AVAILABLE IN BOTH COLORS.

ALFI® HANDY



8 HOUR TEMPERATURE RETENTION

Polypropylene exterior with glass interior. Features Take A-Part lid. Stackable. Specify color when ordering. **Hand wash/do not submerge.**

Case pack: 1 each.

HANDY.6 .6 LITER (20 OZ)
8.75" X 4.75" (22.2 CM X 12 CM)

HANDY1 1 LITER (33.8 OZ)
9.75" X 5.25" (24.8 CM X 13.3 CM)

PARTS	145G.	6 LITER GLASS LINER
	57G	1 LITER GLASS LINER
	9352A	WHITE LID FOR HANDY1 & 6
	9352E	BLACK LID FOR HANDY1 & 6
	9404	LID GASKET

ALFI® NEAT NEW



8 HOUR TEMPERATURE RETENTION

Plastic exterior with glass interior and vacuum insulation. Screw top. **Dishwasher safe.**

Case pack: 1 each.



1915010
WHITE

1915010060 .6 LITER (20 OZ)
6.5" X 5.5" X 9.25" (16.5 CM X 14 CM X 23.5 CM)

1915010100 1 LITER (33.8 OZ)
6.5" X 9.5" (16.5 CM X 24 CM)

1915010150 1.5 LITER (50.7 OZ)
6.5" X 10.25" (16.5 CM X 26 CM)

PARTS	9103010065	REPLACEMENT LID
-------	------------	-----------------

ALFI® DIANA NEW



8 HOUR TEMPERATURE RETENTION

Plastic exterior with glass interior and vacuum insulation. Features a push-button lid. Specify color when ordering. No replacement lids available.

Hand wash/do not submerge.

Case pack: 1 each.

0925xxx100 1 LITER(33.8 OZ)
6.75" X 6" X 9.25" (17.2 CM X 14 CM X 23.5 CM)



0925037100
037 / RED



0925062100
062 / BLUE



0925073100
073 / LIME



0925096100
096 / YELLOW



0925109100
109 / ORANGE



WHY ALFI?

Alfi decanters bring taste to your table. In every possible way.

HOT LOOKS

Award-winning designers like Ole Palsby and Tassilo von Grolman partner with Alfi to create servers that make a statement. The Alfi brand is known worldwide as the ultimate in chic.

HOT DRINKS

Years of research on heat flow, heat conduction, and heat radiation give Alfi unmatched performance. Vacuum-insulated, double-walled Alfi Dur-Hard glass with silver lacquering ensures that virtually no heat can escape.

COOL OPTIONS

Alfi provides a range of servers to fit any budget and application, including those with double-walled, vacuum-pumped, stainless steel inserts, which perform nearly as well as glass—and won't break.

Choose Alfi—and choose the style that sets you apart.

CUSTOM ENGRAVING & REPAIR

Increase awareness and reinforce your brand with Custom Engraving. We engrave right on carafes, turning them into personalized statements. Lead time with camera ready artwork is four weeks.

\$2.00 LIST PER LETTER, LOGOS TO BE QUOTED; 12 EACH MINIMUM.

ALFI CARAFES WITH MINIMAL DAMAGE MAY BE REFURBISHED.

\$20.00 PER HOUR CHARGE PLUS PARTS AT STANDARD DISCOUNT. CALL FOR ESTIMATES.



1852 / CHROME
.65L, 1L AVAILABLE



1854 / SILVER
SPECIAL ORDER

ALFI® SAPHIR PREMIUM GLASS CARAFE

 8 HOUR TEMPERATURE RETENTION

Brass with polished chrome finish exterior, glass interior and vacuum insulation. Handmade and polished, crafted in traditional design. Features a stopper lid. **Hand wash/do not submerge.**

Case pack: 1 each.

185265 CHROME .65 LITER (22 OZ)
8.75" X 3.75" (22.2 CM X 9.5 CM)

18521 CHROME 1 LITER (33.8 OZ)
10" X 4.25" (25.4 CM X 10.5 CM)

AVAILABLE BY SPECIAL ORDER—CALL FOR PRICING. (8 WEEK LEAD TIME):

18541 SILVER 1 LITER (33.8 OZ)
10" X 4.25" (25.4 CM X 10.5 CM)

PARTS **185L65** .65 LITER GLASS LINER
185L1 1 LITER SAPHIR/ACHAT GLASS LINER
571LID CHROME LID AND HINGE
57LGAS LINER GASKET



692 / CHROME
.65L, 1L, 1.5L, 2L AVAILABLE



6941 / SILVER
SPECIAL ORDER

ALFI® OPAL PREMIUM GLASS CARAFE

 8 HOUR TEMPERATURE RETENTION

Brass with polished chrome finish exterior, glass interior and vacuum insulation. Handmade and polished, crafted in traditional design. Features a stopper lid. Optional stainless liner page 20.

Hand wash/do not submerge.

Case pack: 1 each.

69265 CHROME .65 LITER (22 OZ)
8.25" X 4.5" (20.6 CM X 11.4 CM)

6921 CHROME 1 LITER (33.8 OZ)
9" X 5.25" (22.8 CM X 13 CM)

69215 CHROME 1.5 LITER (50.7 OZ)
10.5" X 5.75" (26.6 CM X 14.6 CM)

6922 CHROME 2 LITER (67.6 OZ)
12" X 5.75" (30.4 CM X 14.6 CM)

AVAILABLE BY SPECIAL ORDER—CALL FOR PRICING. (8 WEEK LEAD TIME):

6941 SILVER 1 LITER (33.8 OZ)
9" X 5.25" (22.8 CM X 13 CM)

PARTS **57L65** .65 LITER LINER
57L1 1 LITER LINER
57L15 1.5 LITER LINER
57L2 2 LITER LINER
571LID CHROME LID AND HINGE
57LGAS LINER GASKET



572
CHROME
.5L, 1L, 1.5L AVAILABLE



5741
SILVER
SPECIAL ORDER



WORK TOGETHER IDEA;
COORDINATE YOUR LOOK



2121260800
WHITE



144265
.65L



14421
1L



144215
1.5L

ALL 3 SIZES AVAILABLE IN POLISHED FINISH.



0930270100
ALUMINUM SATIN
1L



0937205100
MATTE STAINLESS
1L

ALFI® JUWEL PREMIUM GLASS CARAFE



8 HOUR TEMPERATURE RETENTION

Brass with polished chrome finish exterior with glass interior. Handmade and polished, crafted in traditional design with a stopper lid. Optional stainless liner page 20.

Hand wash/do not submerge.

Case pack: 1 each.

5725	CHROME .5 LITER (16.9 OZ) 7.25" X 3.5" (18.4 CM X 8.9 CM)
57210	CHROME 1 LITER (33.8 OZ) 9" X 4" (22.8 CM X 10.2 CM)
57215	CHROME 1.5 LITER (50.7 OZ) 11.25" X 5.5" (28.5 CM X 14 CM)

AVAILABLE BY SPECIAL ORDER—CALL FOR PRICING. (8 WEEK LEAD TIME):

5741	SILVER 1 LITER (33.8 OZ) 9" X 4" (22.8 CM X 10.2 CM)
------	---

PARTS	57L5	.5 LITER LINER
	57L1	1 LITER LINER
	57L15	1.5 LITER LINER
	571LID	CHROME LID AND HINGE LID
	57LGAS	LINER GASKET
	STOPPER	.8 LITER - 2 LITER STOPPER
	STOPPER2	.35 LITER - .75 LITER STOPPER

ALFI® JUWEL CREAMER/SUGAR

Made from white ceramic. Creamer nests on top of the sugar bowl.

Hand wash.

Case pack: 1 each.

2121260800	SUGAR/CREAMER 4.5" X 2.25" X 3.5" (11.4 CM X 5.7 CM X 8.9 CM)
------------	--

ALFI® ALBERGO GLASS CARAFE



8 HOUR TEMPERATURE RETENTION

Stainless exterior with glass interior. Features a push-button lid. Special order .65 and 1.5 liter. Optional stainless steel liner, page 21.

Hand wash/do not submerge.

Case pack: 1 each.

144265	.65 LITER (22 OZ) 8.5" X 5.5" X 7" (21.6 CM X 14 CM X 17.8 CM)
14421	1 LITER (33.8 OZ) 10.25" X 5.75" X 7.75" (26 CM X 14.6 CM X 19.7 CM)
144215	1.5 LITER (50.7 OZ) 11.5" X 5.75" X 8" (29.2 CM X 14.6 CM X 20.3 CM)

PARTS	1442999070	.65 LITER GLASS LINER
	14321L	1 LITER GLASS LINER
	1442 999 150	1.5 LITER GLASS LINER
	1432LID	1 LITER LID WITH TEA INFUSER

ALFI® DAN



8 HOUR TEMPERATURE RETENTION

Stainless or aluminum exterior with glass interior. Features screw top lid with wide mouth for easy cleaning.

Hand wash/do not submerge.

Case pack: 1 each.

0930270100	1 LITER (33.8 OZ) ALUMINUM 7.5" X 6.25" X 9" (15.1 CM X 15.9 CM X 22.9 CM)
0937205100	1 LITER (33.8 OZ) STAINLESS 7.5" X 6.25" X 9" (15.1 CM X 15.9 CM X 22.9 CM)

PARTS	0935999100	REPLACEMENT LINER
	9103211064	REPLACEMENT LID

CLASSY™ VACUUM CARAFE



CJ
SS / BRUSHED
STAINLESS W/
BLACK

CJ
CH / POLISHED
STAINLESS

CJ
BS / BRUSHED
STAINLESS
W/ BRUSHED
STAINLESS
1 LITER ONLY

CJ
WHG / WHITE
PLASTIC W/
GOLD
1 LITER ONLY

2 SIZES AVAILABLE, ALL 4 FINISHES AVAILABLE IN 1 LITER ONLY.



8 HOUR TEMPERATURE RETENTION

Stainless exterior with glass interior and vacuum insulation. Features a push button lid. Specify color when ordering. Lid with orange trigger for decaf may be substituted by adding "D" after model number. **Hand wash/do not submerge.**

Case pack: 6 each.

CJ6	.6 LITER (20 OZ.) 9.25" X 5" X 5.75" (23.5 CM X 12.7 CM X 14.6 CM)
CJ10	1 LITER (33.8 OZ) 11" X 5.5" X 6.25" (27.9 CM X 14 CM X 15.9 CM)

PARTS	CJRL6	.6 LITER GLASS LINER FOR CJ6
	CJRL1	1 LITER GLASS LINER FOR CJ10
	CJRL1BL	BLACK LID FOR CJ10, 6 (CASE PACK 6)
	CJRL1BLD	BLACK DECAF LID FOR CJ10, 6 (CASE PACK 6)
	CJRL1CH	MIRRORED FINISH LID FOR CJ10, 6CH (CASE PACK 6)
	CJRL1CHD	MIRRORED FINISH DECAF LID FOR CJ10, 6CH (CASE PACK 6)
	CJL1WHG	WHITE LID FOR CJ10 (CASE PACK 6)



CGC060
SS / BRUSHED
STAINLESS W/ BLACK

CGC101
CP / COPPER
W/ BROWN

BOTH SIZES AVAILABLE IN BOTH FINISHES.

CLASSIC GLASS CARAFE™



8 HOUR TEMPERATURE RETENTION

Durable metal exterior with glass interior. Features a virtually dripless spout with 1/8" turn stopper top, tilt to pour. Optional stainless liner page 24. Specify color when ordering. Lid for decaf may be substituted by adding "D" after model number. **Hand wash/do not submerge.**

Case pack: 6 each.

CGC060	.6 LITER (20 OZ) 8.5" X 4.75" X 6.25" (21.6 CM X 12.1 CM X 15.9 CM)
CGC101	1 LITER (33.8 OZ) 10" X 4.5" X 6.25" (25.4 CM X 17.8 CM X 12.1 CM)

PARTS	CGRL6	.6 LITER GLASS LINER
	CGRL1	1 LITER GLASS LINER
	CGSTOP1	BLACK STOPPER LID (CASE PACK 6)
	CGSTOP2	BROWN STOPPER LID (CASE PACK 6)
	CGSTOPOR	ORANGE STOPPER LID (CASE PACK 6)

DON'T FORGET YOUR CLEANER!

Keep your product looking great.



12632
PAGE 49



TPS10
STAINLESS W/
BLACK
1L

TPS16
STAINLESS W/
BLACK
1.6L

TPS19
STAINLESS W/
BLACK
1.9L

ALL 3 SIZES AVAILABLE IN STAINLESS FINISH.

PUSH N' SERV™



Stainless exterior with glass interior and vacuum insulation. Features an ergonomically friendly design with push button on handle. Lid with orange inset for decaf may be substituted by adding "D" after model number.

Hand wash/do not submerge.

Case pack: 6 each.

TPS10	1 LITER (33.8 OZ) 10" X 5.75" X 7.5" (25.4 CM X 14.6 CM X 19.1 CM)
TPS16	1.6 LITER (54 OZ) 12.25" X 5.75" X 7.5" (31.1 CM X 14.6 CM X 19.1 CM)
TPS19	1.9 LITER (64.2 OZ.) 13.25" X 6" X 7.5" (33.7 CM X 15.2 CM X 19.1 CM)

PARTS	DX10	1 LITER GLASS LINER FOR TPS10
	DX16	1.6 LITER GLASS LINER FOR TPS16
	DX19	1.9 LITER GLASS LINER FOR TPS19
	TPSGAS	LINER GASKET FOR TPS19
	TPSLID	BLACK LID FOR TPS10, 16, 19 (CASE PACK 6)
	TPSLIDOR	DECAF LID FOR TPS10, 16, 19 (CASE PACK 6)

ULTRA CARAFE



Stainless exterior with glass interior and vacuum insulation. Features Click N' Pour or Brew N' Pour™ dishwasher safe lids. Since it fits under most "airpot" brewers feel free to brew directly into it. Lid for decaf may be substituted by adding "D" after model number. **Hand wash/do not submerge.**

Case pack: 6 each.



PXS19BTL
BRUSHED STAINLESS
W/ BLACK

PXS19C	1.9 LITER (64.2 OZ) WITH CLICK N' POUR LID 12.75" X 6.25" X 7.75" (32.6 CM X 15.4 CM X 19.6 CM)
PXS19BTL	1.9 LITER (64.2 OZ) WITH BREW N' POUR LID 12.75" X 6.25" X 7.75" (32.6 CM X 15.4 CM X 19.6 CM)

PARTS	DX19	1.9 LITER GLASS LINER FOR PXS19
	PXSL	BLACK CLICK N' POUR LID FOR PXS19
	PXSLOL	ORANGE LID FOR PXS19 (CASE PACK 6)
	PXSBTL	BLACK BREW N' POUR LID FOR PXS19BTL (CASE PACK 6)
	PXSBTLOR	ORANGE BREW N' POUR LID FOR PXS19BTL (CASE PACK 6)

IDENTIFICATION MAGNETS

Magnetic identification labels available in packs of 6 each. Your choice of plain in over 23 flavors or in a variety pack that includes 1 of each flavor. Flavors: Milk, 2% Milk, Skim Milk, Half & Half, Cream, Hot Water, Tea, Ice Tea, Coffee, Decaf, Regular, Breakfast Blend, Colombian, French Roast, Gourmet Blend, House Blend, Almond, Amaretto, French Vanilla, Hazelnut, Irish Cream, Mocha, Blank. Specify flavor when ordering.

NEW 2 sizes of coffee bean style available in Colombian, Decaf, House Blend, French Roast. Specify flavor when ordering.

Sold in Case Pack of 6 only. Variety Pack 1 of each flavor.

MT1xx	PLAIN INDIVIDUAL TAGS ORDER AS 6 EACH (3.5" X 1.25")
MT1VPA	VARIETY PACK 1 EACH OF 23 (3.5" X 1.25")
MTCB1xx	COFFEE BEAN STYLE TAG (3" X 1") (CASE PACK 6)
MTCB4xx	COFFEE BEAN STYLE TAG (6" X 4") (CASE PACK 6)

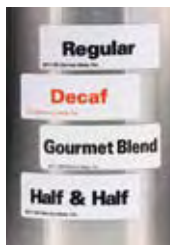

MT
IDENTIFICATION
MAGNETS



MTCB1/MTCB4
IDENTIFICATION
MAGNETS



WORK TOGETHER IDEA; COORDINATE YOUR LOOK WITH TES AIRPOTS ON PG.45

CLASSY™ VACUUM CARAFE



CJ6
SS / BRUSHED
STAINLESS W/
BLACK



CJ10
CH / POLISHED
STAINLESS



CJ
BS / BRUSHED
STAINLESS
W/ BRUSHED
STAINLESS
1 LITER ONLY



CJ10
WHG / WHITE
PLASTIC W/
GOLD
1 LITER ONLY

2 SIZES AVAILABLE, ALL 4 FINISHES AVAILABLE IN 1 LITER ONLY.



8 HOUR TEMPERATURE RETENTION

Stainless exterior with glass interior and vacuum insulation. Features a push button lid. Specify color when ordering. Lid with orange trigger for decaf may be substituted by adding "D" after model number. **Hand wash/do not submerge.**

Case pack: 6 each.

CJ6	.6 LITER (20 OZ.) 9.25" X 5" X 5.75" (23.5 CM X 12.7 CM X 14.6 CM)
CJ10	1 LITER (33.8 OZ) 11" X 5.5" X 6.25" (27.9 CM X 14 CM X 15.9 CM)

PARTS	CJRL6	.6 LITER GLASS LINER FOR CJ6
	CJRL1	1 LITER GLASS LINER FOR CJ10
	CJRL1BL	BLACK LID FOR CJ10, 6 (CASE PACK 6)
	CJRL1BLD	BLACK DECAF LID FOR CJ10, 6 (CASE PACK 6)
	CJRL1CH	MIRRORED FINISH LID FOR CJ10, 6CH (CASE PACK 6)
	CJRL1CHD	MIRRORED FINISH DECAF LID FOR CJ10, 6CH (CASE PACK 6)
	CJL1WHG	WHITE LID FOR CJ10 (CASE PACK 6)



CGC060
SS / BRUSHED
STAINLESS W/ BLACK



CGC101
CP / COPPER
W/ BROWN

BOTH SIZES AVAILABLE IN BOTH FINISHES.

CLASSIC GLASS CARAFE™



8 HOUR TEMPERATURE RETENTION

Durable metal exterior with glass interior. Features a virtually dripless spout with 1/8" turn stopper top, tilt to pour. Optional stainless liner page 24. Specify color when ordering. Lid for decaf may be substituted by adding "D" after model number. **Hand wash/do not submerge.**

Case pack: 6 each.

CGC060	.6 LITER (20 OZ) 8.5" X 4.75" X 6.25" (21.6 CM X 12.1 CM X 15.9 CM)
CGC101	1 LITER (33.8 OZ) 10" X 4.5" X 6.25" (25.4 CM X 17.8 CM X 12.1 CM)

PARTS	CGRL6	.6 LITER GLASS LINER
	CGRL1	1 LITER GLASS LINER
	CGSTOP1	BLACK STOPPER LID (CASE PACK 6)
	CGSTOP2	BROWN STOPPER LID (CASE PACK 6)
	CGSTOPOR	ORANGE STOPPER LID (CASE PACK 6)

DON'T FORGET YOUR CLEANER!

Keep your product looking great.



12632
PAGE 49



SPECIALTY

SERVERS

If you're going to make an impression, make it incredible. And if you're going to make coffee, why not make it French press? We've got everything you need to leave a lasting impression on any guest—whether you want hand-pressed coffee, loose-leaf tea, or perfectly chilled iced drinks. Add an extra shot of sophistication and flavor to any affair with just the right server.

HOW TO USE A FRENCH PRESS

1. Warm glass bowl beforehand and fill with appropriate amount of medium ground coffee or tea. One heaped teaspoon (approximately 10g.) for one cup.
2. For best results pour water which has just come to a boil, place lid on and let steep.
3. After grounds or tea leaves settle towards bottom (approximately 3 minutes), push filter down and pour.



2120 050 040
STAINLESS
.5L



2120 120 040
STAINLESS
1.2L

ALFI® COFFEE MAKER

Made from 18/10 stainless steel with double-wall insulation. Features a traditional press system. **Hand wash.**

Case pack: 1 each.

2120 050 040 .5 LITER (16 OZ)

7.75" X 3" X 5.5" (19.7 CM X 7.6 CM X 14 CM)

2120 120 040 1.2 LITER (40.6 OZ)

9.5" X 4" X 6.75" (24.1 CM X 10.2 CM X 17.1 CM)



T277B
STAINLESS
.35L



T477B
STAINLESS
.6L



T677B
STAINLESS
.8L

ALL 3 SIZES AVAILABLE IN STAINLESS FINISH.

SERVICE IDEAS BRICK PRESS

Constructed from stainless with a Pyrex glass liner. Features a brick pattern. **Hand wash.**

Case pack: 1 each.

T277B CHROME .35 LITER (12.3 OZ) MAKES 2 CUPS.

4.6" X 3.6" X 8" (11.7 CM X 9.1 CM X 20.3 CM)

T477B CHROME .6 LITER (20 OZ) MAKES 4 CUPS.

5.8" X 4.4" X 8.5" (14.7 CM X 11.2 CM X 21.6 CM)

T677B CHROME .8 LITER (27.1 OZ) MAKES 6 CUPS.

6" X 4.8" X 9.8" (15.2 CM X 12.2 CM X 24.9 CM)

PARTS	L3	GLASS LINER 277
		5" X 2.75" (12.5 CM X 6.9 CM)
	L4	GLASS LINER 477
		6" X 3.5" (15 CM X 8.8 CM)
	L6	GLASS LINER 677
		6" X 3.75" (15 CM X 9.4 CM)



350CCG
CCG / GOLD
.35L

600CC
CC / CHROME
.6L

800CCG
CCG / GOLD
.8L



1000CC
CC / CHROME
1L



1500CCG
CCG / GOLD
1L

ALL 5 SIZES AVAILABLE IN BOTH FINISHES.

SERVICE IDEAS PRESS

Metal holder with Pyrex glass liner. Makes the freshest cup of coffee or tea that will enhance any dining experience. Specify finish when ordering. Note "G" for gold finish. **Liners dishwasher safe.**

Case pack: 1 each.

CHROME

- 350CC** .35 LITER (12.3 OZ) MAKES 2 CUPS.
7.5" X 3" X 5" (19 CM X 7.6 CM X 12.7 CM)
- 600CC** .6 LITER (20 OZ) MAKES 4 CUPS.
8.5" X 3.5" X 6" (21.6 CM X 8.8 CM X 15.2 CM)
- 800CC** .8 LITER (27.1 OZ) MAKES 6 CUPS.
9" X 4" X 7" (22.9 CM X 10.2 CM X 17.8 CM)
- 1000CC** 1 LITER (33.8 OZ) MAKES 8 CUPS.
9.5" X 4.5" X 7" (22.5 CM X 11.4 CM X 17.8 CM)
- 1500CC** 1.5 LITER (50.7 OZ) MAKES 10 CUPS.
9.75" X 5" X 7.5" (24.8 CM X 12.7 CM X 19 CM)

- PARTS**
- L3 GLASS LINER 350
5" X 2.75" (12.5 CM X 6.9 CM)
- L4 GLASS LINER 600
6" X 3.5" (15 CM X 8.8 CM)
- L6 GLASS LINER 800
6" X 3.75" (15 CM X 9.4 CM)
- L8 GLASS LINER 1000
7" X 3.75" (17.5 CM X 9.4 CM)
- L12 GLASS LINER 1500
7.125" X 4.5" (17.8 CM X 11.3 CM)



2109060040
STAINLESS
.6 L

2109 140 040
STAINLESS
1.4L

ALFI® TEEKANNE

Constructed from 18/10 stainless steel. Features a removable stainless steel tea filter. **Hand wash.**

Case pack: 1 each.

- 2109060040** .6 LITER (20 OZ)
3.5" X 5.5" (9 CM X 14 CM)
- 2109 140 040** 1.4 LITER (47.3 OZ)
7.5" X 4.75" X 7.75" (19.1 CM X 12.1 CM X 19.7 CM)



T600CC
CHROME
.6L



T600CCG
GOLD
.6L

SERVICE IDEAS TEA POT

Metal holder with glass interior. Make tea to order. **Liners dishwasher safe.**

Case pack: 1 each.

- T600CC** CHROME .6 LITER (20 OZ)
6.5" X 5.5" X 6.5" (17.5 CM X 14 CM X 16.5 CM)
- T600CCG** GOLD .6 LITER (20 OZ)
6.5" X 5.5" X 6.5" (17.5 CM X 14 CM X 16.5 CM)

- PARTS** TL4 GLASS LINER



BREWING TEA

- Use Fresh or bottled water whenever possible. Water quality is important to the flavor of the tea.
- For black teas, bring the water to a full rolling boil, but do not over-boil the water. For green teas, bring the water just to the boiling point (steaming.)
- Fill your teapot with hot water to pre-warm before adding tea leaves and hot water to the pot.
- Add one level teaspoon of tea leaves for every cup of water. Tea strainers and infusing baskets may be used, or the leaves may be added directly to the pot.
- Pouring hot water over tea leaves starts the steeping process.
- Steep full black leaves four to five minutes. Steep delicate green teas and smaller leaf teas for three minutes.
- Experiment with brewing times and the amount of tea leaves used to adjust to your own taste.



TB006
6 COMPARTMENT

TB012
12 COMPARTMENT

TEA CHEST

Constructed from Beachwood, lid from plexiglass. The tea boxes feature a see through lid with individual compartments for merchandising and storing tea. **Wipe with dry cloth.** Compartments measure 2.375" L x 2.125" W x 2" D.

Case pack: 1 each.

TB006 6 COMPARTMENT
2.75" X 8.25" X 7.25" (7 CM X 21 CM X 18.5 CM)

TB012 12 COMPARTMENT
2.75" X 11" X 10.75" (7 CM X 28 CM X 27.5 CM)



LO01Z
BLACK
.75L

LO02Z
BLACK
1.2L

BOTH SIZES AVAILABLE IN BLACK CERAMIC.



WORK TOGETHER IDEA: COORDINATE YOUR LOOK WITH ECO-LINE TUSCANY GLASS ON PG.5

CERAMIC 'CAST IRON LOOK' TEA POT

Constructed from ceramic. This tea pot features the look of cast iron, but is light weight ceramic. Includes infuser basket.

Hand wash.

Case pack: 1 each.

LO01Z .75 LITER (24.1 OZ)
5.25" X 7" X 6" (13.5 CM X 18 CM X 15 CM)

LO02Z 1.2 LITER (40.6 OZ)
5.75" X 8" X 6.5" (14.5 CM X 20 CM X 16.5 CM)

PARTS LTPLBL LID FOR LOOxZ
LTPB INFUSER BASKET FOR LOOxZ



1301W
WHITE W/ POLISHED STAINLESS
.9L
.6L, 1.3L AVAILABLE



1300W BODY

BREDEMEIJER® COSY - LOWER PRICING

Constructed from earthenware. Features a stainless jacket to retain temperature. **Hand wash.**

Case pack: 1 each.

1300W	.6 LITER (20 OZ) 5.5" X 5" X 8.75" (14.9 CM X 12.7 CM X 22.3 CM)
1301W	.9 LITER (30.4 OZ) 6.5" X 5.75" X 9.5" (17 CM X 14.7 CM X 24.1 CM)
1302W	1.3 LITER (44 OZ) 7.25" X 6.5" X 10.75" (18.3 CM X 16.7 CM X 27.6 CM)

PARTS	1300WBODY	COSY .6 L BODY
	1300WLID	COSY LID FOR .6 L



WORK TOGETHER IDEA;
COORDINATE YOUR LOOK



1417W
WHITE



1418W
WHITE

BREDEMEIJER® COSY CREAMER/SUGAR

Constructed from earthenware. **Hand wash.**

Case pack: 1 each.

1417W	6 OZ COSY SUGAR BOWL 4" X 3.75" (10 CM X 9.5 CM)
--------------	---

1418W	6 OZ COSY CREAMER 3.25" X 5.5" (8.7 CM X 13.8 CM)
--------------	--



1505W
POLISHED STAINLESS
.6L



3510W
BRUSHED
1L

BOTH SIZES AVAILABLE IN BOTH FINISHES.

BREDEMEIJER® MANTO - LOWER PRICING

Constructed from earthenware. Features a stainless jacket to retain temperature. **Hand wash.**

Case pack: 1 each.

1505W	.6 LITER (20 OZ) POLISHED STAINLESS STEEL 6" X 4.25" X 7.5" (14.5 CM X 10.5 CM X 19 CM)
1510W	1 LITER (33.8 OZ) POLISHED STAINLESS STEEL 7" X 5" X 9" (18 CM X 12.6 CM X 23 CM)
3505W	.6 LITER (20 OZ) BRUSHED 6" X 4.25" X 7.5" (14.5 CM X 10.5 CM X 19 CM)
3510W	1 LITER (33.8 OZ) BRUSHED 7" X 5" X 9" (18 CM X 12.6 CM X 23 CM)

PARTS	1505WBODY	COSY MANTO .6L BODY
	1505WJACKET	COSY MANTO .6L JACKET
	1505WLID	COSY MANTO .6L LID (FITS ON 3505)
	1510WBODY	COSY MANTO 1L BODY
	1510WJACKET	COSY MANTO 1L JACKET
	1510WLID	COSY MANTO 1L LID (FITS ON 3510)



1301W
WHITE W/ POLISHED STAINLESS
.9L
.6L, 1.3L AVAILABLE



1300W BODY

BREDEMEIJER® COSY - LOWER PRICING

Constructed from earthenware. Features a stainless jacket to retain temperature. **Hand wash.**

Case pack: 1 each.

1300W	.6 LITER (20 OZ) 5.5" X 5" X 8.75" (14.9 CM X 12.7 CM X 22.3 CM)
1301W	.9 LITER (30.4 OZ) 6.5" X 5.75" X 9.5" (17 CM X 14.7 CM X 24.1 CM)
1302W	1.3 LITER (44 OZ) 7.25" X 6.5" X 10.75" (18.3 CM X 16.7 CM X 27.6 CM)

PARTS	1300WBODY	COSY .6 L BODY
	1300WLID	COSY LID FOR .6 L



WORK TOGETHER IDEA;
COORDINATE YOUR LOOK



1417W
WHITE



1418W
WHITE

BREDEMEIJER® COSY CREAMER/SUGAR

Constructed from earthenware. **Hand wash.**

Case pack: 1 each.

1417W	.6 OZ COSY SUGAR BOWL 4" X 3.75" (10 CM X 9.5 CM)
--------------	--

1418W	.6 OZ COSY CREAMER 3.25" X 5.5" (8.7 CM X 13.8 CM)
--------------	---



1505W
POLISHED STAINLESS
.6L



3510W
BRUSHED
1L

BOTH SIZES AVAILABLE IN BOTH FINISHES.

BREDEMEIJER® MANTO - LOWER PRICING

Constructed from earthenware. Features a stainless jacket to retain temperature. **Hand wash.**

Case pack: 1 each.

1505W	.6 LITER (20 OZ) POLISHED STAINLESS STEEL 6" X 4.25" X 7.5" (14.5 CM X 10.5 CM X 19 CM)
1510W	1 LITER (33.8 OZ) POLISHED STAINLESS STEEL 7" X 5" X 9" (18 CM X 12.6 CM X 23 CM)
3505W	.6 LITER (20 OZ) BRUSHED 6" X 4.25" X 7.5" (14.5 CM X 10.5 CM X 19 CM)
3510W	1 LITER (33.8 OZ) BRUSHED 7" X 5" X 9" (18 CM X 12.6 CM X 23 CM)

PARTS	1505WBODY	COSY MANTO .6L BODY
	1505WJACKET	COSY MANTO .6L JACKET
	1505WLID	COSY MANTO .6L LID (FITS ON 3505)
	1510WBODY	COSY MANTO 1L BODY
	1510WJACKET	COSY MANTO 1L JACKET
	1510WLID	COSY MANTO 1L LID (FITS ON 3510)



TB600CC
BLACK
.6L

TB1200CC
BLACK
1.2L



TPC10
BL / BLACK

TPC10
FG / FOREST GREEN



TPC16
WH / WHITE

BOTH SIZES AVAILABLE IN ALL 4 COLORS.



TS612
AL / ALMOND

TS612
BL / BLACK

TS612
BU / BURGUNDY

TS612
CBT / COBALT
BLUE



TS612
FG / FOREST
GREEN

TS612
GR / GRAY

TS612
MV / MAUVE



TS612
ST/BR /
STONEWARE
W/ BROWN

TS612
ST/BU /
STONEWARE W/
BURGUNDY

TS612
ST/COB /
STONEWARE W/
COUNTRY BLUE

TS612
WH / WHITE



TST612
QTZ / QUARTZ

TST612
RUBY / RUBY

TST612
SPH / SAPHIRE

TEA BALL

Plastic exterior with a glass liner. Features a removable tea basket and portion spoon included. **Liners dishwasher safe.**

Case pack: 1 each.

TB600CC	.6 LITER (20 OZ) 5.25" X 5.75" X 4" (13.3 CM X 14.6 CM X 10.2 CM)
TB1200CC	1.2 LITER (40 OZ) 6.75" X 7.5" X 5.25" (17.1 CM X 19 CM X 13.3 CM)

PARTS	CALL FOR PRICING. SPECIFY PART WHEN ORDERING.
TB600PARTS	LID, BODY, COLLAR, GLASS LINER, SCOOP
TB600BSK	INFUSER BASKET

CERAMIC TEA POT

Constructed from ceramic. Features a clip on/off lid and new infuser basket. Specify color when ordering. **Dishwasher safe.**

Case pack: 6 each.

TPC10	.3 LITER (10 OZ) 5.75" X 4.25" X 3" (14.6 CM X 10.8 CM X 7.6 CM)
TPC16	.5 LITER (16 OZ) 6.25" X 5" X 3.25" (15.9 CM X 12.7 CM X 8.3 CM)

PARTS	TPCLS5 CLIP ON STAINLESS LID
	TPCBSK BASKET 10 OZ OR 16 OZ

PLASTIC TEAPOT



Plastic construction with double wall insulation. Stackable. Tether option to attach lid. Optional custom crestring available. Specify color when ordering. Customization Options: Custom color - 400 each minimum. Molded insert - \$1,400 net, 36 initial and reorder minimum. **Dishwasher safe.**

Case pack: 6 each.

STANDARD	
TS612	.5 LITER (16 OZ) 6" X 3.5" (15.2 CM X 8.9 CM)

TETHER	
TST612	.5 LITER (16 OZ) WITH TETHER 6" X 3.5" (15.2 CM X 8.9 CM)

JEWEL COLORS	
TST612	.5 LITER (16 OZ) TRANSPARENT WITH TETHER 6" X 3.5" (15.2 CM X 8.9 CM)

PARTS	TPL	16 OZ TEAPOT LID (CASE PACK 12)
	TPLT	16 OZ TEAPOT LID WITH TETHER (CASE PACK 12)

↔ WORK TOGETHER IDEA; COORDINATE YOUR LOOK WITH NEW GENERATION SERVERS ON PG.16



1135974075 974 / WATER BLUE
 1135033075 033 / CHERRY RED
 1135010075 010 / MILKY WHITE



1135971075 971 / ORANGE
 1135970075 970 / ICE TEA



AWP19SB/PWP19SB
 CLEAR
 1.9L



AWP24BS/PWP28BS
 CLEAR
 2.4L OR 2.8L



AWP33RB
 CLEAR
 3.3L



AWP33SB/PWP33SB
 CLEAR
 3.3L

3 SIZES AVAILABLE IN BOTH MATERIALS.



S12LITCL
 CLEAR
 2L

ALFI® COOL BOTTLE

Cool design for cold drinks. Features the unique Inside Out-Look to view content level. An extra large all-round pouring opening and fresh colors to designate drinks. **Hand wash.**

Case pack: 1 each.

1135xxx075 .75 LITER (25.5 OZ) WATER BLUE
 4.5" X 11" (11.4 CM X 27.9 CM)

PARTS 1135999075 LINER FOR COOL BOTTLE
 FBSL LID FOR COOL BOTTLE



WORK TOGETHER IDEA; COORDINATE YOUR LOOK WITH KUGEL CARAFES ON PG.25

ICE TUBE PITCHER

Constructed from clear acrylic or polycarbonate. The ice tube allows you to chill without diluting liquids. Great for juice.

Handwash only with soft sponge and non-abrasive cleaner.

Case pack: 6 each.

ACRYLIC

AWP19SB 1.9 LITER (64.2 OZ) SMOOTH BODY
 10.5" X 6" X 7.5" (26.7 CM X 15.2 CM X 19.1 CM)
 AWP24BS 2.4 LITER (81.1 OZ) BELL SHAPE
 11.25" X 4" X 8" (28.5 CM X 10 CM X 20 CM)
 AWP33SB 3.3 LITER (111.5 OZ) SMOOTH BODY
 11.75" X 4" X 7.5" (30 CM X 10 CM X 19 CM)
 AWP33RB 3.3 LITER (111.5 OZ) RIBBED BODY
 11.5" X 4" X 8" (29 CM X 10 CM X 20 CM)

POLYCARBONATE

PWP19SB 1.9 LITER (64.2 OZ) SMOOTH BODY
 10.5" X 6" X 7.5" (26.7 CM X 15.2 CM X 19.1 CM)
 PWP28BS 2.8 LITER (94.7 OZ) BELL SHAPE
 11.25" X 4" X 8" (28.5 CM X 10 CM X 20 CM)
 PWP33SB 3.3 LITER (111.5 OZ) SMOOTH BODY
 11.75" X 4" X 7.5" (30 CM X 10 CM X 19 CM)

PARTS AWPLI LID/COVER FOR AWP/PWP (2.4 L, 2.8 L, 3.3 L)
 (CASE PACK 6)
 AWPLI19 LID/COVER FOR AWP/PWP (1.9 L)
 (CASE PACK 6)
 AWPICE ICE TUBE FOR AWP/PWP
 (CASE PACK 6)

SCULPTURED ICE™ PITCHER



Constructed from S.A.N. plastic. Lid available, stackable.

Dishwasher safe.

Case pack: 6 each.

S12LITCL 2 LITER (67.6 OZ) CLEAR PITCHER WITH LID
 8.25" X 4.5" (21 CM X 11.4 CM)

PARTS S12LITCOC LID FOR S12LITCL



WPS2
STAINLESS
2L

WATER PITCHER

Constructed from stainless steel. Features a traditional shape with ice guard. **Hand wash.**

Case pack: 1 each/master 6.

WPS2	2 LITER (67.6 OZ) 6" X 7.75" X 7.5" (15 CM X 19.5 CM X 19 CM)
------	--



X7025
STAINLESS
1.9L

STAINLESS PITCHER

Constructed from stainless steel. Features a sleek look with chrome finish and ice guard. **Dishwasher safe.**

Case pack: 1 each/master 12.

X7025	1.9 LITER (64 OZ) 10" X 4" (25.4 CM X 10.2 CM)
-------	---



FROTH206
STAINLESS
.6L

FROTH326
STAINLESS
1L

FROTH506
STAINLESS
1.5L

FROTH646
STAINLESS
1.9L

4 SIZES AVAILABLE IN STAINLESS FINISH.



FROTHING PITCHERS

Stainless steel construction. Features an opening to hold thermometer and internal content level lines in 6 ounce increments. Thermometer sold separately. **Dishwasher safe.**

Case pack: 1 each.

FROTH206	.6 LITER (20 OZ) 4.25" X 3.5" (10.5 CM X 8.9 CM)
FROTH326	.95 LITER (32 OZ) 5" X 4" (12.7 CM X 10.2 CM)
FROTH506	1.5 LITER (50 OZ) 6" X 4.25" (15.2 CM X 10.8 CM)
FROTH646	1.9 LITER (64 OZ) 6.75" X 4.5" (17.1 CM X 11.4 CM)

PARTS	60721	5" STEM THERMOMETER
	8216	8" STEM THERMOMETER



PCB18
BLACK
1.8L

DECANTER

Polycarbonate plastic body with a stainless base. Features a removable decaf rubber grip on the handle. Empty decanter must be immediately removed from heat source. **Dishwasher safe.**

Case pack: 12 each

PCB18	1.8 LITER (60 OZ) 6.75" X 6.5" X 8" (17.1 CM X 16.5 CM X 20.3 CM)
-------	--

PARTS	DSOR18	DECANTER SLEEVE ORANGE
-------	--------	------------------------

TR1412RI
STAINLESSTR1412
STAINLESSTR1412SR
STAINLESS

WORK TOGETHER IDEA; COORDINATE YOUR LOOK WITH THE CLASSY (CJ10BS) SERVERS ON PG.31 AND SUGAR/CREAMER (SSC85) ON PG.14

IBT12CH
POLISHED STAINLESSIB13SS
STAINLESS

WORK TOGETHER IDEA; COORDINATE YOUR LOOK WITH ZEPÉ (GSP1S) BEVERAGE SERVERS ON PG.52

IB3
BL / BLACK1130SI
STAINLESS

1124SI

NON-SLIP TRAY NEW

Constructed from 18/8 stainless steel. Features 3 non-slip options molded in rubber grips, solid rubber, and removable rubber mat to prevent slipping. Stackable. **Dishwasher safe.**

Case pack: 1 each/master case 12 each.

TR1412RI TRAY WITH REMOVABLE INSERT
14" (35 CM), INSIDE 11.5" (29 CM)

TR1412SR TRAY WITH SOLID RUBBER SURFACE
14" (35 CM), INSIDE 11.5" (29 CM)

TR1412 TRAY WITH RUBBER GRIPS
14" (35 CM), INSIDE 11.5" (29 CM)

PARTS TR-RI RUBBER INSERT FOR TR1412RI

ICE BUCKET WITH TONGS

Constructed from stainless steel. Features double-wall body, tongs that are stored in the lid and drip tray. **Hand wash.**

Case pack: 12 each.

IBT12CH
5.75" X 6.75" (14.6 CM X 17.1 CM)

PARTS TONGS REPLACEMENT TONGS

STEEL ICE BUCKET

Constructed from stainless steel. Double-wall virtually eliminates condensation, includes drip tray. **Hand wash.**

Case pack: 6 each.

IB13SS 3 LITER (101.4 OZ)
7" X 7" (17.8 CM X 17.8 CM)

PARTS IBSSPARTS INSIDE DISK

ICE BUCKET



MADE IN THE USA

Constructed from ABS plastic with double-wall insulation. Double-wall virtually eliminates condensation. **Dishwasher safe.**

Case pack: 6 each.

IB3 3 LITER (101.4 OZ)
9.25" X 7.5" X 8.25" (24.1 CM X 19.1 CM X 21 CM)

PARTS IBL3BL BLACK LID

FIRST AID KIT



MADE IN THE USA

Features quality and brand name first aid supplies for aches/pains, eye care, cuts/scraps, thermal, disinfectant and more.

1124SI FIRST AID KIT, 173 PIECES (25 PERSON) (9" X 9" X 3")

1130SI FIRST AID KIT, 30 PIECES (4" X 2.5")

FORM + FUNCTION

AIRPOTS



AIRPOTS IS IT POSSIBLE TO CREATE PERSONALLY SERVED AMBIANCE WITH A SELF-SERVE SET UP? ABSOLUTELY. OUR STAND-ALONE SERVERS COME IN THE SIZE AND STYLE YOU WANT, WITH THE FEATURES THAT MAKE ANY GUEST FEEL PAMPERED. AN ELEGANT FORM IS USELESS WITHOUT A MEANINGFUL FUNCTION. WE DELIVER BOTH. WHILE YOUR CUSTOMERS ARE NOTICING THE UNIQUE DESIGN OF YOUR AIRPOTS, YOU'LL BE SEEING THAT YOUR BEVERAGES ARE SERVED EXACTLY THE WAY YOU WANT.



SERVICE IDEAS' ECO-AIR® "BUILD YOUR OWN" AIRPOTS

Mix and match your choice of shell, liner and lid, to customize all of our Eco-Air® airpots to get exactly what you need. Not sure how to get the airpot you want? Our customer service representatives can help you with that.





PLASTIC
BLACK (BL)



PLASTIC
BURGUNDY (BU)



PLASTIC
FOREST GREEN (FG)



PLASTIC
WHITE (WH)

ECO-AIR® GLASS LINED



8 HOUR TEMPERATURE RETENTION - GLASS LINED



Plastic or stainless exterior with glass interior and vacuum insulation. Durable plastic shell helps prevent denting. Interchangeable lever or decaf lid options. Lid with orange pump or lever release button for decaf may be substituted by adding "D" after model number. Specify color when ordering a plastic exterior. **Hand wash/do not submerge.**

Case pack: 1 each.

PUMP LID	LEVER LID	DESCRIPTION	DIMENSIONS
ECA19S	ECAL19S	1.9 LITER (64.2 OZ) SMOOTH STAINLESS STEEL	14.5" X 6" X 8" (36.8 CM X 15.2 CM X 20.3 CM)
ECA22S	ECAL22S	2.2 LITER (74.4 OZ) SMOOTH STAINLESS STEEL	15.25" X 6" X 8" (38.7 CM X 15.2 CM X 20.3 CM)
ECA22Pxx	ECAL22P xx	2.2 LITER (74.4 OZ) SHINY PLASTIC (BL, BU, FG, WH)	15.25" X 6" X 8" (38.7 CM X 15.2 CM X 20.3 CM)
ECA22PBLMAT	ECAL22PBLMAT	2.2 LITER (74.4 OZ) RIBBED MATTE PLASTIC (BL)	15.25" X 6" X 8" (38.7 CM X 15.2 CM X 20.3 CM)
ECA22SBPBLMAT	ECAL22SBPBLMAT	2.2 LITER (74.4 OZ) SMOOTH MATTE PLASTIC (BL)	15.25" X 6" X 8" (38.7 CM X 15.2 CM X 20.3 CM)
ECAJ22S	ECAJL22S	2.2 LITER (74.4 OZ) STAINLESS STEEL JEWEL SHELL	15.25" X 6" X 8" (38.7 CM X 15.2 CM X 20.3 CM)
ECA25S	ECAL25S	2.5 LITER (84.5 OZ) SMOOTH STAINLESS STEEL	16.5" X 6" X 8" (41.9 CM X 15.2 CM X 20.3 CM)
ECA25SBPBLMAT	ECAL25SBPBLMAT	2.5 LITER (84.5 OZ) SMOOTH MATTE PLASTIC (BL)	16.5" X 6" X 8" (41.9 CM X 15.2 CM X 20.3 CM)

ECO-AIR® STAINLESS LINED



4-6 HOUR TEMPERATURE RETENTION - GLASS LINED



Plastic or stainless exterior with stainless interior and vacuum insulation. Durable plastic shell helps prevent denting. Unbreakable liner, interchangeable lever or decaf lid options. Optional stainless steel liner gives you 2.4L capacity. Lid with orange pump or lever release button for decaf may be substituted by adding "D" after model number. Specify color when ordering plastic exterior.

Hand wash/do not submerge.

Case pack: 1 each.

PUMP LID	LEVER LID	DESCRIPTION	DIMENSIONS
ECAS22Pxx	ECALS22Pxx	2.4 LITER (81.1 OZ) SHINY PLASTIC (BL, BU, FG, WH)	15.25" X 6" X 8" (38.7 CM X 15.2 CM X 20.3 CM)
ECAS22PBLMAT	ECALS22PBLMAT	2.4 LITER (81.1 OZ) RIBBED MATTE PLASTIC (BL)	16.5" X 6" X 8" (41.9 CM X 15.2 CM X 20.3 CM)
ECAS22SBPBLMAT	ECALS22SBPBLMAT	2.4 LITER (81.1 OZ) SMOOTH MATTE PLASTIC (BL)	16.5" X 6" X 8" (41.9 CM X 15.2 CM X 20.3 CM)
ECAJS22S	ECAJLS22S	2.4 LITER (81.1 OZ) STAINLESS STEEL JEWEL SHELL	15.25" X 6" X 8" (38.7 CM X 15.2 CM X 20.3 CM)
ECAS22S	ECALS22S	2.4 LITER (81.1 OZ) SMOOTH STAINLESS STEEL	15.25" X 6" X 8" (38.7 CM X 15.2 CM X 20.3 CM)



PLASTIC
MATTE RIBBED



PLASTIC
MATTE SMOOTH



STAINLESS
SMOOTH



STAINLESS
JEWELLED



ECONOMY
STAINLESS
SECA

ECONOMY STAINLESS LINED



4-6 HOUR TEMPERATURE RETENTION

Stainless steel exterior and interior with vacuum insulation. Unbreakable liner, interchangeable lever and decaf lids. Lid with orange pump or lever release button for decaf may be substituted by adding "D" after model number. **Hand wash/do not submerge.**

Case pack: 1 each/master 6.

PUMP LID	LEVER LID	DESCRIPTION	DIMENSIONS
SECA19S	SECAL19S	1.9 LITER (64.2 OZ) STAINLESS STEEL	8" X 5.5" X 12.5" (20.3 CM X 14 CM X 31.8 CM)
SECA22S	SECAL22S	2.2 LITER (74.4 OZ) STAINLESS STEEL	8" X 5.5" X 13" (20.3 CM X 14 CM X 33 CM)
SECA25S	SECAL25S	2.5 LITER (84.5 OZ) STAINLESS STEEL	8" X 6" X 14" (20.3 CM X 15.2 CM X 35.6 CM)
SECA30S	SECAL30S	3 LITER (101.4 OZ) STAINLESS STEEL	8" X 6" X 14" (20.3 CM X 15.2 CM X 35.6 CM)

ECO-AIR® AND ECONOMY PARTS

ECO-AIR® LINERS

ERL19	GLASS LINER FOR ECA19
ERL22	GLASS LINER FOR ECA22
ERL25	GLASS LINER FOR ECA25
ERL22SS	STAINLESS STEEL LINER FOR ECAS22
KITECASS25	CONVERSION KIT FOR SWITCHING GLASS LINER TO STAINLESS INCLUDES SS LINER, SUCTION PIPE, GASKET

ECO-AIR® AND ECONOMY SUCTION PIPE

ESP19	SUCTION PIPE FOR ECA19
ESP22	SUCTION PIPE FOR ECA22
ESP25	SUCTION PIPE FOR ECA25
ESP22SS	SUCTION PIPE FOR ECAS22SS
SESP19	SUCTION PIPE FOR SECA19S
SESP22	SUCTION PIPE FOR SECA22S
SESP25	SUCTION PIPE FOR SECA25S
SESP3	SUCTION PIPE FOR SECA30S

ECO-AIR® AND ECONOMY LIDS

ELLBL	LEVER LID
ELLBLORT	DECAF LEVER LID (RELEASE BUTTON ORANGE)
ELLOR	ALL ORANGE LEVER LID
EPL22BL	PUMP LID
EPLOR	DECAF PUMP LID (PUMP ORANGE)
EPL22OR	ALL ORANGE PUMP LID

ECO-AIR® GASKET

ECAGAS3	LID GROMMET GASKET
ECAGAS7	LINER GASKET
ECAGAS4A	SUCTION PIPE COLLAR GASKET
ECAGAS4B	SUCTION PIPE END GASKET

FLAVOR STICKERS

FSDRT	FLAVOR STICKERS (DECAF, TEA, REGULAR)
-------	--



SERVICE IDEAS' ECO-AIR® "BUILD YOUR OWN" AIRPOTS

Don't see exactly what you need listed? That's okay, we allow you to customize all of our Eco-Air® airpots to get exactly what you need.

Mix and match your choice of shell, liner and lid, then you know that you'll get just what you want.

Not sure how to get the airpot you want? Our customer service representatives can help you with that.



PNWASTD250
BLACK
2.5L



PNWA250
WITH OGH8811
BLACK
2.5L

GRAVITY-SERV™

8 HOUR TEMPERATURE RETENTION



Plastic exterior with a glass interior and vacuum insulation. Features a sight glass to view content level and draw off dispensing. Fits most stands. **Hand wash.**

Case pack: 1 each.

PNWA250 2.5 LITER (84.5 OZ) 12" X 8" (30.5 CM X 20.3 CM)

PNWASTD250 2.5 LITER (84.5 OZ) WITH STAND

OGH8811 ADJUSTABLE PLASTIC STAND FOR PNWA250
8" X 8" X 11" (20.3 CM X 20.3 CM X 27.9 CM)

PARTS	PNWALINER	LINER FOR PNWA250
	PNWALID	LID FOR PNWA250
	PNWAHNDL	HANDLE FOR PNWA250
	PNWAFACE	PANEL CAP FOR PNWA250
	PNWABASE	BASE FOR PNWA250
	PNWCASE	CASE FOR PNWA250
	PNWASGCAP	SIGHT GLASS CAP FOR PNWA250
	PNWASGK	SIGHT GLASS KIT FOR PNWA250
	PNWAVLV	BOTTOM VALVE FOR PNWA250
	PNWAVTK	VALVE & TUBING KIT FOR PNWA250
	PNWALEVER	LEVER FOR PNWA250

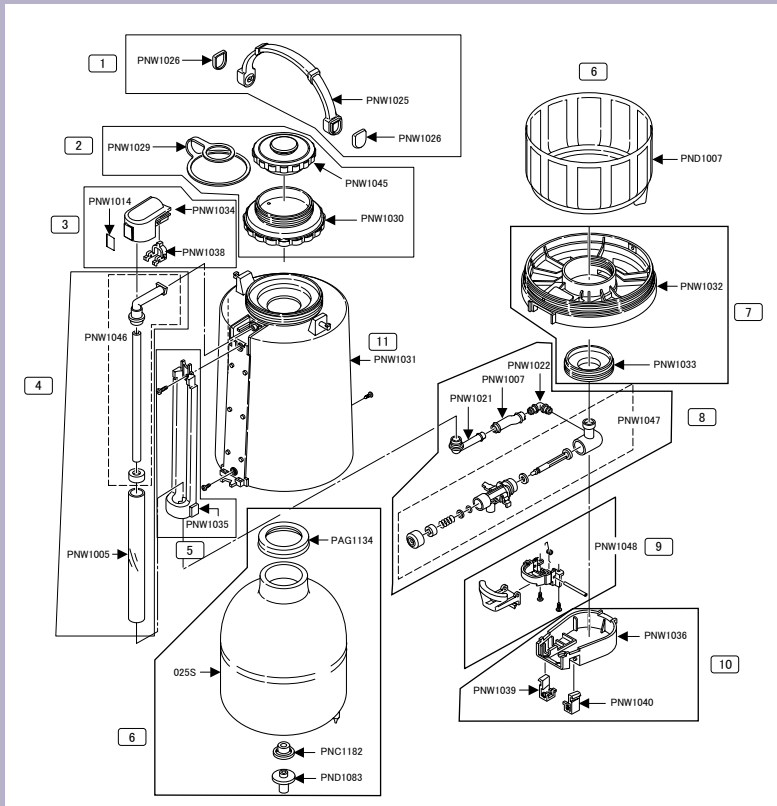

GRAVITY-SERV™ PARTS DIAGRAM

1. HANDLE (PNWAHNDL)
2. LID (PNWALID)
3. PANEL CAP (PNWAFACE)
4. SIGHT GLASS KIT (PNWASGK)
5. SIGHT GLASS CAP (PNWASGCAP)
6. GLASS LINER (PNWALINER)
7. BASE (PNWABASE)
8. VALVE & TUBING KIT (PNWAVTK)
9. LEVER ASSEMBLY (PNWALEVER)
10. BOTTOM VALVE (PNWAVLV)
11. BODY CASE (PNWCASE)





APCL22CH
CHROME W/MODERN HANDLES
PUMP AVAILABLE



APC22
CHROME/BRASS
LEVER AVAILABLE



APCTSCH
CHROME W/ MODERN HANDLES
LEVER AVAILABLE



APCLTS
CHROME/BRASS
PUMP AVAILABLE



WORK TOGETHER IDEA; COORDINATE YOUR LOOK WITH ID CHAINS ON PG.48



RRA3
BLACK



RRA6C
BLACK



DT412AL
BLACK WITH
ALLUMINUM



DT412BL
BLACK



DT412GD
BLACK WITH GOLD

AIRPOT COVER-UPS

Stainless steel construction with brass accents. Dress up and extends life of airpots. Fits multiple airpots with adjustable base (APCTS) or Eco-Air 2.2L (APC22). Upon request available with contemporary handles and silver plated, 4-6 week lead time may apply. **WIPE WITH CLOTH TO CLEAN.**

Case pack: 1 each.

ECO-AIR

APC22	BRASS ACCENT, HOLDS 2.2 LITER ECA22 PUMP AIRPOT 17" X 9" X 12" (43.2 CM X 22.9 CM X 30.5 CM)
APC22CH	ALL CHROME, HOLDS 2.2 LITER ECA22 PUMP AIRPOT 17" X 9" X 12" (43.2 CM X 22.9 CM X 30.5 CM)
APCL22	BRASS ACCENT, HOLDS 2.2 LITER ECAL22 LEVER AIRPOT 17" X 9" X 12" (43.2 CM X 22.9 CM X 30.5 CM)
APCL22CH	ALL CHROME, HOLDS 2.2 LITER ECAL22 LEVER AIRPOT 17" X 9" X 12" (43.2 CM X 22.9 CM X 30.5 CM)

PREMIUM AIRPOTS

APCTS	BRASS ACCENT, HOLDS ALL TES/SSA PUMP LID AIRPOTS 18" X 10" X 13" (45.7 CM X 25.4 CM X 33 CM)
APCTSCH	ALL CHROME, HOLDS ALL TES/SSA PUMP LID AIRPOTS 18" X 10" X 13" (45.7 CM X 25.4 CM X 33 CM)
APCLTS	BRASS ACCENT, HOLDS ALL TES/SSA LEVER LID AIRPOTS 18" X 10" X 13" (45.7 CM X 25.4 CM X 33 CM)
APCLTSCH	ALL CHROME, HOLDS ALL TES/SSA LEVER LID AIRPOTS 18" X 10" X 13" (45.7 CM X 25.4 CM X 33 CM)

PARTS	APC22PL	ECO PUMP BRASS ACCENT COVER-UP LID
	APC22PLCH	ECO PUMP CHROME COVER-UP LID
	APCLL	ECO LEVER BRASS ACCENT COVER-UP LID
	APCLLCH	ECO LEVER CHROME COVER-UP LID
	APCTSLID	PREMIUM PUMP BRASS ACCENT COVER-UP LID
	APCTSCHLID	PREMIUM PUMP CHROME COVER-UP LID
	APCTSLL	PREMIUM LEVER BRASS ACCENT COVER-UP LID
	APCTSLLCH	PREMIUM LEVER CHROME COVER-UP LID

ROTO RACK NEW

Black powder coated steel. Lazy susan rotation for counter space savings, holds up to 3 or 6 Eco-Air®, 6" airpots, optional sign holder for marketing coffee. **Airpots not included. Hand wipe.**

Case pack: 1 each.

RRA3C	HOLDS 1-3 AIRPOTS PLUS 1 LARGE DRIP TRAY(DT412BL), SIGN KIT AND 3 OCTAGONAL DRIP TRAYS 24.25"H X 20"DIA (61.6 CM X 50.8 CM)
RRA3	HOLDS 1-3 AIRPOTS PLUS 1 LARGE DRIP TRAY 24.25"H X 20"DIA (61.6 CM X 50.8 CM)
RRA6C	HOLDS 1-6 AIRPOTS PLUS 1 LARGE DRIP TRAY(DT412BL), SIGN KIT AND 6 OCTAGONAL DRIP TRAYS 24.25"H X 20"DIA (61.6 CM X 50.8 CM)
RRA6	HOLDS 1-6 AIRPOTS PLUS 1 LARGE DRIP TRAY 24.25"H X 20"DIA (61.6 CM X 50.8 CM)

PARTS	RRKIT3	KIT INCLUDES 3 OCTAGON DRIP TRAYS AND HARDWARE
	RRSIGNKIT	SIGN KIT INCLUDES SIGN TOPPER AND POLE
	RRTOOL	HEX WRENCH TOOL
	DT412	4" X 12" RECTANGULAR LARGE DRIP TRAY

DRIP TRAY NEW

Constructed from black styrene and metal drain tray. **Hand wash.**

Case pack: 1 each.

DT412AL	ALUMINUM DRIP TRAY 12" X 4"
DT412BL	BLACK DRIP TRAY 12" X 4"
DT412GD	GOLD DRIP TRAY 12" X 4"



PNUA220
BLACK
2.2L
3L AVAILABLE

BLACKTIE™ SIGHT GLASS GLASS LINED



8 HOUR TEMPERATURE RETENTION

Plastic exterior with a glass interior and vacuum insulation. Features an easy to view content level with flushed to body sight glass.

Hand wash/do not submerge.

Case pack: 1 each.

PNUA220 2.2 LITER (74 OZ)
13" X 7.25" X 9" (33 CM X 18.4 CM X 22.9 CM)

PNUA300 3.0 LITER (101.4 OZ)
14.5" X 7.25" X 9" (36.8 CM X 18.4 CM X 22.9 CM)

PARTS PNUA22L BLACK PUMP LID FOR 2.2L
PNUA3L BLACK PUMP LID FOR 3L

STEELVAC™ STAINLESS LINED SIGHT GLASS



4-6 HOUR TEMPERATURE RETENTION

Stainless steel exterior and interior with vacuum insulation. Interchangeable lever or decaf lid options. Exterior sight glass to view content levels with extra sightglass and cleaning brush. Lid with orange pump or lever release button for decaf may be substituted by adding "D" after model number.

Hand wash/do not submerge.

Case pack: 1 each.

SSA300SG 3 LITER (101.4 OZ) PUMP LID WITH SIGHT GLASS
15.5" X 7.25" X 9.75" (39.4 CM X 18.4 CM X 24.8 CM)

SSAL300SG 3 LITER (101.4 OZ) LEVER LID WITH SIGHT GLASS
15.5" X 7.25" X 9.75" (39.4 CM X 18.4 CM X 24.8 CM)

PARTS SSALL LEVER LID
SSALLOR DECAF LEVER LID
SSAPL PUMP LID
SSALOR DECAF PUMP LID
SSASGC SIGHT GLASS AND BRUSH
SSASP300 3L SUCTION PIPE



SSA300SG
STAINLESS
3L
LEVER LID AVAILABLE

PREMIUM GLASS LINED



8 HOUR TEMPERATURE RETENTION

Stainless steel exterior with glass interior and vacuum insulation. Innovative suction pipe prevents back flow into lid. Lid with orange pump for decaf may be substituted by adding "D" after model number.

Hand wash/do not submerge.

Case pack: 1 each.

PUMP LID LEVER LID DESCRIPTION

PUMP LID	LEVER LID	DESCRIPTION
TES22	TESL22	2.2 LITER (74 OZ) 13.25" X 6.75" X 9.75" (33.7 CM X 17.1 CM X 24.8 CM)
TES25	TESL25	2.5 LITER (84.5 OZ) 14" X 7" X 9.75" (35.6 CM X 17.8 CM X 24.8 CM)
TES30	TESL30	3 LITER (101.4 OZ) 15" X 7.25" X 9.75" (38.1 CM X 18.4 CM X 24.8 CM)

PARTS O22Y GLASS LINER FOR TES22
O25Y GLASS LINER FOR TES25
O30W GLASS LINER FOR TES30
TESLID BLACK PUMP LID
TESLIDOR DECAF PUMP LID
TESLL BLACK LEVER LID
TESLLOR DECAF LEVER LID
TESP22 2.2 LITER SUCTION PIPE
TESP25 2.5 LITER SUCTION PIPE
TESP30 3 LITER SUCTION PIPE
TESGAS LINER GASKET



TES22
STAINLESS
2.2L



TESL22
STAINLESS
2.2L



SSA250
STAINLESS
2.5L
3L, 3.75L AVAILABLE



SSAL250
STAINLESS
2.5L
3L, 3.75L AVAILABLE

STEELVAC™ STAINLESS LINED



4-6 HOUR TEMPERATURE RETENTION

Stainless steel exterior and interior with vacuum insulation. Interchangeable lever or decaf lid options. Lid with orange pump or lever release button for decaf may be substituted by adding "D" after model number. **Hand wash/do not submerge.**

Case pack: 1 each.

PUMP LID	LEVER LID	DESCRIPTION
SSA250	SSAL250	2.5 LITER (84.5 OZ) 14.5" X 7.25" X 9.75" (36.8 CM X 18.4 CM X 24.8 CM)
SSA300	SSAL300	3 LITER (101.4 OZ) 15.5" X 7.25" X 9.75" (39.4 CM X 18.4 CM X 24.8 CM)
SSA375	SSAL375	3.75 LITER (126.8 OZ) 17" X 7.25" X 9.75" (43.2 CM X 18.4 CM X 24.8 CM)

PARTS	SSALL	LEVER LID
	SSALLOR	DECAF LEVER LID (RELEASE BUTTON ORANGE)
	SSAPL	PUMP LID
	SSALOR	DECAF PUMP LID (PUMP ORANGE)
	SSASP250	2.5L SUCTION PIPE
	SSASP300	3L SUCTION PIPE
	SSASP375	3.75L SUCTION PIPE

AIRPOT PARTS DIAGRAM

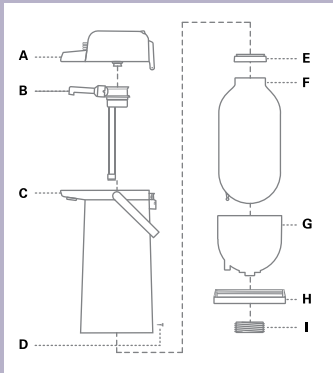

- A Lid (includes: bellows, lid gasket)
- B Suction Pipe (includes: collar gasket, tip gasket, tube, spout)
- C Exterior Stainless Steel or Plastic Body
- D Screw (may need to unscrew to remove liner)
- E-G Glass Liner (includes: E-rubber gasket, F-liner, G-plastic protector on glass liner)
- H Black Base
- I Plug (center bottom)

3-STEP TROUBLESHOOTING

If liquid is not dispensing or liquid is not staying hot, the following are possible solutions.

1. Tighten the center plug, located in the center of the bottom base, to secure the liner and gasket against the collar of the airpot.
2. When airpot is empty, pump or push the lever of the lid and check for airflow against the palm of your hand.
3. Inspect suction pipe for cracks.

If your airpot does not work after checking for these problems, call Customer Service at 800-328-4493.

CARE/HANDLING

How to Use: For optimal retention, flip open lid and preheat airpot with warm water. Empty water and begin brewing directly into the airpot if your brewer allows you to do so, or refill with hot beverage. Close lid. Glass airpot will retain optimal retention for 8+ hours, Steel airpot will retain optimal retention for 4-6 hours. Avoid careless handling such as tilting, tipping, dropping or any strong impact which may result in damage to the liner and vacuum seal.

Liner replacement: Remove lid. Unscrew metal screw at base of airpot. While holding airpot over garbage loosen bottom plug enough to unscrew entire base. Remove base and carefully remove broken glass and liner gasket. Cautiously wipe out interior with damp cloth until all glass particles are disposed. Insert new liner with new gasket. Replace base and secure liner in place by re-tightening plug. Finally, replace screw and lid.

How to clean exterior: Wipe with a soft damp cloth, follow with a dry cloth. **How to clean interior:** Clean with luke warm water and mild detergent and rinse with hot water. Never submerge in water, place in dishwasher, use brush that may scratch glass liner or use harsh cleaners.

STORAGE

Best if stored in a cool, dry place with lid off.

APPLICATION SUGGESTIONS

Vacuum Glass Airpots: 8+ hour retention required

Stainless Steel Airpots: 4 hour retention required, unbreakable stainless liner ideal for heavy duty applications, transporting

Plastic Outershell Airpots: Available in five colors, these economy airpots offer a durable plastic exterior that eliminates denting and adds color

ACCESSORIES

Static labels, Airpot racks, Airpot Cover-Ups and ID Chains.

WARRANTY

As a distributor of fine products, Service Ideas, Inc. is interested in knowing about any problems you may experience. We will work with you individually to determine if the problem is caused by a manufacturer's defect.

PACKAGING

For UPS approved shipping carton please add "P" to model number and \$2.00 net.



APCL22CH
CHROME W/MODERN HANDLES
PUMP AVAILABLE



APC22
CHROME/BRASS
LEVER AVAILABLE



APCTSCH
CHROME W/ MODERN HANDLES
LEVER AVAILABLE



APCLTS
CHROME/BRASS
PUMP AVAILABLE



WORK TOGETHER IDEA; COORDINATE YOUR LOOK WITH ID CHAINS ON PG.48



RRA3
BLACK



RRA6C
BLACK



DT412AL
BLACK WITH
ALLUMINUM



DT412BL
BLACK



DT412GD
BLACK WITH GOLD

AIRPOT COVER-UPS

Stainless steel construction with brass accents. Dress up and extends life of airpots. Fits multiple airpots with adjustable base (APCTS) or Eco-Air 2.2L (APC22). Upon request available with contemporary handles and silver plated, 4-6 week lead time may apply. **WIPE WITH CLOTH TO CLEAN.**

Case pack: 1 each.

ECO-AIR

APC22	BRASS ACCENT, HOLDS 2.2 LITER ECA22 PUMP AIRPOT 17" X 9" X 12" (43.2 CM X 22.9 CM X 30.5 CM)
APC22CH	ALL CHROME, HOLDS 2.2 LITER ECA22 PUMP AIRPOT 17" X 9" X 12" (43.2 CM X 22.9 CM X 30.5 CM)
APCL22	BRASS ACCENT, HOLDS 2.2 LITER ECAL22 LEVER AIRPOT 17" X 9" X 12" (43.2 CM X 22.9 CM X 30.5 CM)
APCL22CH	ALL CHROME, HOLDS 2.2 LITER ECAL22 LEVER AIRPOT 17" X 9" X 12" (43.2 CM X 22.9 CM X 30.5 CM)

PREMIUM AIRPOTS

APCTS	BRASS ACCENT, HOLDS ALL TES/SSA PUMP LID AIRPOTS 18" X 10" X 13" (45.7 CM X 25.4 CM X 33 CM)
APCTSCH	ALL CHROME, HOLDS ALL TES/SSA PUMP LID AIRPOTS 18" X 10" X 13" (45.7 CM X 25.4 CM X 33 CM)
APCLTS	BRASS ACCENT, HOLDS ALL TES/SSA LEVER LID AIRPOTS 18" X 10" X 13" (45.7 CM X 25.4 CM X 33 CM)
APCLTSCH	ALL CHROME, HOLDS ALL TES/SSA LEVER LID AIRPOTS 18" X 10" X 13" (45.7 CM X 25.4 CM X 33 CM)

PARTS	APC22PL	ECO PUMP BRASS ACCENT COVER-UP LID
	APC22PLCH	ECO PUMP CHROME COVER-UP LID
	APCLL	ECO LEVER BRASS ACCENT COVER-UP LID
	APCLLCH	ECO LEVER CHROME COVER-UP LID
	APCTSLID	PREMIUM PUMP BRASS ACCENT COVER-UP LID
	APCTSCHLID	PREMIUM PUMP CHROME COVER-UP LID
	APCTSLL	PREMIUM LEVER BRASS ACCENT COVER-UP LID
	APCTSLLCH	PREMIUM LEVER CHROME COVER-UP LID

ROTO RACK NEW

Black powder coated steel. Lazy susan rotation for counter space savings, holds up to 3 or 6 Eco-Air®, 6" airpots, optional sign holder for marketing coffee. **Airpots not included. Hand wipe.**

Case pack: 1 each.

RRA3C	HOLDS 1-3 AIRPOTS PLUS 1 LARGE DRIP TRAY(DT412BL), SIGN KIT AND 3 OCTAGONAL DRIP TRAYS 24.25"H X 20"DIA (61.6 CM X 50.8 CM)
RRA3	HOLDS 1-3 AIRPOTS PLUS 1 LARGE DRIP TRAY 24.25"H X 20"DIA (61.6 CM X 50.8 CM)
RRA6C	HOLDS 1-6 AIRPOTS PLUS 1 LARGE DRIP TRAY(DT412BL), SIGN KIT AND 6 OCTAGONAL DRIP TRAYS 24.25"H X 20"DIA (61.6 CM X 50.8 CM)
RRA6	HOLDS 1-6 AIRPOTS PLUS 1 LARGE DRIP TRAY 24.25"H X 20"DIA (61.6 CM X 50.8 CM)

PARTS	RRKIT3	KIT INCLUDES 3 OCTAGON DRIP TRAYS AND HARDWARE
	RRSIGNKIT	SIGN KIT INCLUDES SIGN TOPPER AND POLE
	RRTOOL	HEX WRENCH TOOL
	DT412	4" X 12" RECTANGULAR LARGE DRIP TRAY

DRIP TRAY NEW

Constructed from black styrene and metal drain tray. **Hand wash.**

Case pack: 1 each.

DT412AL	ALUMINUM DRIP TRAY 12" X 4"
DT412BL	BLACK DRIP TRAY 12" X 4"
DT412GD	GOLD DRIP TRAY 12" X 4"



APRR2BL
BLACK



APR2BLC
BLACK



APR3BLC
BLACK

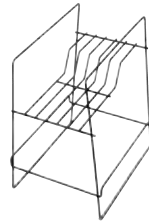

CBR915
BLACK

←→ WORK TOGETHER IDEA; COORDINATE YOUR LOOK WITH AIRPOTS ON PGS.45-46



APS2BL
BLACK



APS1CBL
BLACK



HR21B
BLACK

5 OPTIONS AVAILABLE IN BLACK FINISH

←→ WORK TOGETHER IDEA; COORDINATE YOUR LOOK WITH AIRPOTS ON PGS.45-46



IDCHHW
HOT WATER



IDCHCF
COFFEE

WIRE RACKS

Steel wire with powder coat finish. Connect the APR2 and APR3 together to make a 5 station rack. Drip trays included as shown.

Airpots not included. Hand wash.

Case pack: 1 each.

APR2BLC	2 AIRPOT RACK FITS ALL AIRPOTS 9.5" X 12" X 20.5" (24.1 CM X 30.5 CM X 51.4 CM)
APR3BLC	3 AIRPOT RACK FITS ALL AIRPOTS 14" X 12" X 23.5" (35.5 CM X 30.5 CM X 59.7 CM)
APRR2BL	2 AIRPOT RACK FITS 6" AIRPOTS 25" X 15.75" X 8.25" (63.5 CM X 40 CM X 21 CM)
CBR915	NEW! COFFEE BOX RACK 9" X 15" (22.9 CM X 38.1 CM)

PARTS	DT45 OCTAGON DRIP TRAY 4.5" (11.4 CM)
-------	---------------------------------------

AIRPOT STANDS

Constructed from black styrene with reinforced corners. Features an interlock system. **Airpots not included. Hand wash.**

Case pack: 1 each.

HR21B	HOLDS SINGLE AIRPOT WITH DRIP TRAY 14" X 8.5" (35.6 CM X 21.6 CM)
APS1CBL	HOLDS ONE 6" OR 7.25" AIRPOT AND 3 CONDIMENT BINS 24.5" X 7.25" X 16" (61.6 CM X 18.4 CM X 40.6 CM)
APS2BL	HOLDS TWO 6" OR 7.25" AIRPOTS 24.25" X 7.75" X 16.25" (61.6 CM X 19.7 CM X 41.3 CM)

PARTS	HAP9SH PLASTIC SIGN HOLDER WITH GOLD FINISH INCLUDES MOUNTING STEM 4.5" X 3" (11.4 CM X 7.6 CM)
-------	---

IDENTIFICATION CHAINS

Constructed out of metal. Adjustable chain.

Wipe with a damp cloth.

Case pack: 1 each.

IDCH	IDENTIFICATION CHAIN (SPECIFY CF FOR COFFEE, DE FOR DECAF, HW FOR HOT WATER. SPECIFY VAR FOR 2 OF EACH NOTED ABOVE.) 1.5" X 3.5" (3.8 CM X 8.9 CM), CHAIN 25" (63.5 CM)
------	---



HCT2
BLACK



HCT4
BLACK

CONDIMENT HOLDERS

Constructed from black styrene. Organize your condiments with compartments. **Hand wash.**

Case pack: 1 each.

- HCT2** 2 PART CONDIMENT HOLDER
9" X 8" X 7.75" (22.9 CM X 20.3 CM X 19.7 CM)
- HCT4** 4 PART CONDIMENT HOLDER
17.5" X 10" X 7.75" (44.5 CM X 19.7 CM X 19.7 CM)



OCH7715
BLACK



OCH7715C
BLACK



SC1090
BLACK

COMPARTMENT CONDIMENT ORGANIZER



Constructed from black styrene. Organized compartments for condiments. **Hand wash.**

Case pack: 24 each.

- OCH7715** **NEW!** 3 PART OCTAGON OPEN CONDIMENT HOLDER
7" X 7" X 15" (17.8 CM X 17.8 CM X 38.1 CM)
- OCH7715C** **NEW!** 3 PART OCTAGON CLOSED CONDIMENT HOLDER
7" X 7" X 15" (17.8 CM X 17.8 CM X 38.1 CM)
- SC1090** 6 COMPARTMENT ORGANIZER
13.75" X 7.75"
CIRCLES: 3.25" DIAMETER, 0.5" DEEP
RECTANGLE: 7.75" X 1.25", 4.25" X 2.75", 2.5" X 6", ALL 0.5" DEEP



01212
FOR: DECANTER
BOWLS, GLASS &
STAINLESS LINED
CARAFES AND
AIRPOTS



12732
FOR: MILK FROTHER
& STEAM WAND



12632
FOR: ESPRESSO
MACHINE



12806
FOR: ESPRESSO
GRINDER



00226
FOR: BREW BASKET

CDCC COFFEE AND TEA DISPENSER CLEANERS

Biodegradable, non-toxic cleaners. Fast, safe, easy cleaning with single rinse and NO scrubbing. Effective for glass, plastic and stainless steel materials. Detailed "How To Use" instructions on individual products.

- 01212** 12 OZ DRY GLASS BOWL CLEANER
(CASE PACK 1 EACH) 24 USES
- 00226** .75 OZ FILTER POUCH BREW BASKET CLEANER
(CASE PACK 25 EACH)
- 40647** 7 OZ ACTIVATING DESCALING BREWER PLUMBING CLEANER
(CASE PACK 1 EACH) NOT PICTURED
- 12632** 32 OZ ESPRESSO MACHINE CLEANER
(CASE PACK 1 EACH)
- 12732** 32 OZ MILK FROTHER AND STEAM WAND CLEANER
(CASE PACK 1 EACH)
- 12806** 100 TABLETS FOR ESPRESSO GRINDER
(CASE PACK 1 EACH)

BREW N' SERV™ BREWER PACKAGES



SIBAPA



SIATAPA



SITATCA



SIBL3PWA

POUR OVER BREWER PACKAGE **NEW**

Sold with two Eco-Air™ glass lined airpots, a six compartment condiment organizer and airpot cleaner.

SIBAPA POUR OVER BREWER PACKAGE
 ELECTRICAL: 120V/1400W/11.7A
 BREW CAPACITY: 1/2 GALLON (1.9L)
 DIMENSIONS: 8.5" X 16.5" X 22.5" (22 CM X 42 CM X 57 CM)
 LISTING: UL, NSF
 FACTORY VOLUME TIMER SET AT 58 OZ—MAX. SETTING 84 OZ

PARTS BREW BASKET
 SPRAY HEAD

AIRPOT AUTOMATIC BREWER PACKAGE **NEW**

Sold with two Eco-Air™ glass lined airpots, a six compartment condiment organizer and airpot cleaner.

SIATAPA AIRPOT AUTOMATIC BREWER PACKAGE
 ELECTRICAL: 120V/1780W/14.8A
 BREW CAPACITY: 75 OZ (2.2L)
 DIMENSIONS: 8.5" X 16.5" X 24.25" (22 CM X 42 CM X 61 CM)
 LISTING: UL, NSF
 FACTORY VOLUME TIMER SET AT 58 OZ—MAX. SETTING 84 OZ

PARTS BREW BASKET
 SPRAY HEAD

THERMAL CARAFE AUTOMATIC BREWER PACKAGE **NEW**

Sold with two Brew N' Pour™ Steelvac Carafes, a six compartment condiment organizer and carafe cleaner.

SITATCA THERMAL CARAFE AUTOMATIC BREWER PACKAGE
 ELECTRICAL: 120V/1780W/14.8A
 BREW CAPACITY: 75 OZ (2.2L)
 DIMENSIONS: 8.5" X 16.5" X 18" (22 CM X 42 CM X 45 CM)
 LISTING: UL, NSF
 FACTORY VOLUME TIMER SET AT 58 OZ—MAX. SETTING 84 OZ

PARTS BREW BASKET
 SPRAY HEAD

3 WARMER POUROVER BREWER PACKAGE **NEW**

Sold with six polycarbonate plastic body decanters with steel base, a six compartment condiment organizer and decanter cleaner.

SIBL3PWA 3 WARMER POUROVER BREWER PACKAGE
 ELECTRICAL: 120V/1700W/14.2A
 BREW CAPACITY: 1/2 GALLON (1.9L)
 DIMENSIONS: 15.5" X 16.5" X 16.5" (40 CM X 42 CM X 42 CM)
 LISTING: UL, NSF
 FACTORY VOLUME TIMER SET AT 58 OZ—MAX. SETTING 84 OZ

PARTS BREW BASKET
 SPRAY HEAD

CALL FOR SPECIAL NET PRICING.

QUALITY + QUANTITY

BUFFET



BUFFET SET YOURSELF UP TO MAKE ANY EVENT UNFORGETTABLE. START WITH OUR LUSH SELECTION OF PREMIUM BUFFET TABLEWARE. GLEAMING STAINLESS-STEEL BEVERAGE DISPENSERS WILL GRACE YOUR TABLE AS POLISHED PLATE TIERS, CRYSTAL-CLEAR CEREAL DISPENSERS DELIVER YOUR DELICACIES. OUR FIRST PRIORITY IS QUALITY. WE DON'T SKIMP ON EXCELLENCE. EACH OF OUR PRODUCTS IS DESIGNED AND BUILT TO WORK WELL WITH PLENTY OF VARIATIONS AND OPTIONS TO SATISFY YOUR OWN TASTE.





LATTE65
STAINLESS
6L



GSP2MIGNON
CHERRY WOOD
4L
7L AVAILABLE
SPECIAL ORDER. 8 WEEK LEAD TIME



GSP1S7
STAINLESS
7L
4L AVAILABLE



GSP1P7W
WHITE
SPECIAL ORDER
ORANGE & BLUE

ZE PÉ BEVERAGE DISPENSERS 3 HOUR TEMPERATURE RETENTION

Base constructed from wood (special order), stainless or polycarbonate, container and tube from polycarbonate plastic, LATTE container from stainless. Features an ice tube that chills without diluting liquids. **Hand wash container in low temperature (under 135 F), wipe off base.** Case pack: 1 each.

GSP1S4	STAINLESS 4 LITER (1 GALLON) 13.5" X 7.25" X 21.5" (34.3 CM X 18.4 CM X 64.6 CM)	PARTS	CONT2	4L CONTAINER
GSP1S7	STAINLESS 7 LITER (1.8 GALLON) 15.5" X 9" X 30" (39.4 CM X 22.9 CM X 76.2 CM)		CONT1	7L CONTAINER
GSP1P7W	WHITE PLASTIC 7 LITER (1.8 GALLON) 8.7" X 15" X 24" (22 CM X 38 CM X 61 CM)		JLID807	4L 807 SERIES STAINLESS LID
LATTE6S	SINGLE INSULATED 6 LITER (1.6 GALLON) 22.5" X 15" (55.9 CM X 38 CM)		JLID8077	7L 807 SERIES STAINLESS LID
80702720	SINGLE STAINLESS 4 LITER (1 GALLON) 7.5" X 13" X 21.3" (19 CM X 33 CM X 54 CM)		JLIDS2	4L STAINLESS LID
80702710	DOUBLE STAINLESS 4 LITER (1 GALLON) 15" X 13" X 21.3" (28 CM X 33 CM X 54 CM)		JLIDS1	7L STAINLESS LID
80702700	SINGLE STAINLESS 7 LITER (1.8 GALLON) 8.7" X 15" X 24" (22 CM X 38 CM X 61 CM)		JLIDP1	7L WHITE PLASTIC LID
80702690	DOUBLE STAINLESS 7 LITER (1.8 GALLON) 17.3" X 15" X 24" (44 CM X 38 CM X 61 CM)		ICE2	4L ICE TUBE ICE2
			ICE1	7L ICE TUBE
			SPIGOT	SPIGOT
			SPIGOT807	807 SERIES SPIGOT
			GSPSDT	4.25" GRATE
			GSPSDT2	4" GRATE
			GSPSDT3	4.75" GRATE

AVAILABLE BY SPECIAL ORDER-CALL FOR PRICING

GSP1L	SINGLE WOOD 7 LITER (1.8 GALLON) 26.25" X 15.5" (66.6 CM X 39.3 CM)
GSP2MIGNON	DOUBLE WOOD 4 LITER (1 GALLON) 20.25" X 12.25" (51 CM X 30.8 CM)
GSP2NINO	DOUBLE WOOD 7 LITER (1.8 GALLON) 28.5" X 15.25" (72.4 CM X 38.7 CM)



80702720
STAINLESS
4L
7L AVAILABLE



80702690
STAINLESS
DOUBLE 7L
4L AVAILABLE



80700610
STAINLESS SINGLE
(HOLDS APPROX. 15 CUPS)



80700620
STAINLESS DOUBLE



MULINO1PW
WHITE SINGLE 3L
MULINO2PW (DOUBLE) AVAILABLE
(HOLDS APPROX. 15 CUPS)



MULINO1L
WOOD SINGLE 3L
SPECIAL ORDER.
8 WEEK LEAD TIME
(HOLDS APPROX. 15 CUPS)

ZE PÉ CEREAL DISPENSERS

Base constructed from wood (special order), stainless or polycarbonate, container from polycarbonate. Features portion control windmill. **Hand wash container in low temperature (under 135 F), wipe off base.** Case pack: 1 each.

- MULINO1PW** SINGLE WHITE PLASTIC 3 LITER (101.4 OZ)
18" X 14" X 12" (45.7 CM X 35.5 CM X 30.5 CM)
- MULINO1S** SINGLE STAINLESS 3 LITER (101.4 OZ)
18" X 14" X 12" (45.7 CM X 35.5 CM X 30.5 CM)
- MULINO1S7** SINGLE STAINLESS 7 LITER (1.8 GALLON)
21.5" X 8.5" (55 CM X 22 CM)
- MULINO2PW** DOUBLE WHITE PLASTIC 3 LITER (101.4 OZ)
20" X 20" X 13" (50.8 CM X 50.8 CM X 33 CM)
- MULINO2S** DOUBLE STAINLESS 3 LITER (101.4 OZ)
20" X 20" X 13" (50.8 CM X 50.8 CM X 33 CM)
- 80700610** SINGLE STAINLESS 3 LITER (101.4 OZ)
7" X 7" X 22.5" (18 CM X 18 CM X 57 CM)
- 80700620** DOUBLE STAINLESS 3 LITER (101.4 OZ)
13" X 7" X 22.5" (33 CM X 18 CM X 57 CM)

AVAILABLE BY SPECIAL ORDER-CALL FOR PRICING

- MULINO1L** SINGLE WOOD 3 LITER (101.4 OZ)
18" X 14" X 12" (45.7 CM X 35.5 CM X 30.5 CM)
- MULINO2L** DOUBLE WOOD 3 LITER (101.4 OZ)
20" X 20" X 13" (50.8 CM X 50.8 CM X 33 CM)

PARTS	CLID	STAINLESS LID 3 LITER
	CLID7	STAINLESS LID 7 LITER
	LID807	807 SERIES STAINLESS CEREAL LID
	WIND	WINDMILL AND HARDWARE
	ZEPEBOWL1	4.75" BOWL 807 SERIES
	ZEPEBOWL2	5.5" BOWL
	CYPACK	CEREAL DISPENSER CONTAINER, PADDLE, HARDWARE

ZE PÉ CLOCHE

Stainless base with a plastic cover. Features a refrigerated tray. **Hand wash with non abrasive, material approved cleaners.**

Case pack: 1 each

CLOCHE1S	REFRIGERATED, DOME STAINLESS TRAY
	22" X 14" X 10.5" (55.9 CM X 35.6 CM X 26.7 CM)

PARTS	50303453	ICEPACK
-------	----------	---------

ZE PÉ YOGURT

Stainless inset with plastic base. Features 2" diameter cut-outs to hold yogurt, bottles, etc. Refrigerated ice packs.

Hand wash with non abrasive, material approved cleaners

Case pack: 1 each

YOGURT28W	28, 2" OPENING TRAY W/BASE
	25" X 17" X 2.5" (64 CM X 43 CM X 6.5 CM)

PARTS	50303453	ICEPACK
-------	----------	---------



MULINO1S7
STAINLESS SINGLE 7L
(HOLDS APPROX. 34 CUPS)



MULINO2S
STAINLESS DOUBLE 3L
MULINO1S (SINGLE) AVAILABLE



CLOCHE1S
STAINLESS



YOGURT28W
WHITE
SPECIAL ORDER ORANGE & BLUE



ZE PÉ SERVING CARTS

Customize a cart to fit your needs. Special order, 8 week lead time. Constructed from solid wood. Locking casters available on pre-assembled carts. **Wipe off with damp cloth.**

Case pack: 1 each.

REQUEST ADDITIONAL CART INFORMATION, PRICING AND CATALOG.

33030400x	RECTANGLE PRE-ASSEMBLED CART	23.6" X 40.2" X 30.7" (60 CM X 102 CM X 78 CM)
43060403x	COOLED DESSERT TOP	23.6" X 35.4" X 24.4" (60 CM X 90 CM X 62 CM)
43040400x	BAR TOP	23.6" X 35.4" X 5.1" (60 CM X 90 CM X 13 CM)
43070403x	COOLED ROLL TOP	23.6" X 35.4" X 11" (60 CM X 90 CM X 28 CM)
43090400x	CHEESE ROLL TOP	23.6" X 35.4" X 11" (60 CM X 90 CM X 28 CM)

FINISHES AVAILABLE - SPECIFY FOR "x":



T / TANGANIKA



N / WALNUT



M / MAHOGANY



P / ROSEWOOD



W / WENGÉ



MANY STYLES AND CONFIGURATIONS ARE AVAILABLE. REQUEST A CATALOG FOR MORE DETAILS.

THERMAL CONTAINER

 6-8 HOUR TEMPERATURE RETENTION



Stainless steel exterior and interior with vacuum insulation. Features a brew-thru top over molded rubber carrying handle for easy grip. Removable base. Two replacement sightglass tubes and brush stored behind capacity gauge. Drip tray included. **NEW** carrying handles included on both sizes. **Hand wash.**

Case pack: 1 each.

GIU15G	1.5 GALLON 19.5" X 8.75" X 13.5" (48.8 CM X 22.2 CM X 34.3 CM)
GIU2G	2 GALLON 23.5" X 8.75" X 13.5" (59.7 CM X 22.2 CM X 34.3 CM)

PARTS	GIU15GFUN	LID AND FILLING TUBE ASSEMBLY FOR GIU15G
	GIU2GFUN	LID AND FILLING TUBE ASSEMBLY FOR GIU2G
	GIU15GSHIELD	GAUGE GLASS SHIELD FOR GIU15G
	GIU2GSHIELD	GAUGE GLASS SHIELD FOR GIU2G
	GIU2GFAUC	HORIZONTAL FAUCET FOR GIU2G/GIU15G
	GIU2GDT	DRIP TRAY FOR GIU2G/GIU15G
	GIU15GKIT	SIGHT GLASS KIT FOR GIU15G
	GIU2GKIT	SIGHT GLASS KIT FOR GIU2G
	GIU2GLIDH	LID WITH HANDLES
	GIUMOUNT	LINER RETAINER AND PLASTIC NUT FOR GIU15G AND 2G
	GIUPLUG	NUT WING FOR BASE, BLACK PLASTIC FOR GIU15G AND 2G
	GIUSTAND	STAINLESS STAND FOR BASE FOR GIU15G AND 2G
	GIUPLSTAND	PLASTIC STAND FOR GIU15 AND GIU2G



BOTH SIZES AVAILABLE IN STAINLESS FINISH

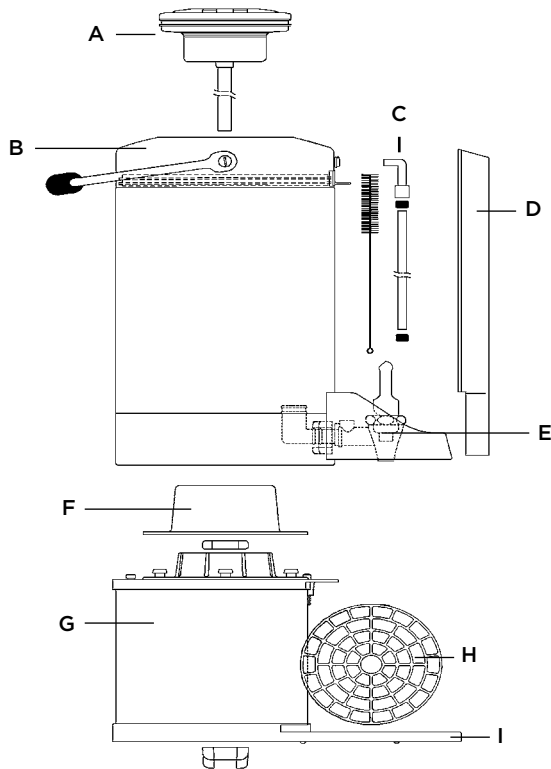

THERMAL CONTAINER PARTS DIAGRAM

- A. LID AND FILLING TUBE ASSEMBLY
- B. LID WITH HANDLES
- C. SIGHT GLASS KIT
- D. GAUGE GLASS SHIELD
- E. FAUCET KIT
- F. LINER MOUNTING AND PLUG
- G. STAND
- H. DRIP TRAY
- I. PLUG (CENTER BOTTOM)





C / CLEAR
AVAILABLE IN SMOKE



BB
C / CLEAR
AVAILABLE IN PEARL AND SMOKE



BCCLG
C / CLEAR
AVAILABLE IN SMOKE



TTONG3W
3 WAY TONGS

BUFFET BOWLS - LOWER CLOSE OUT PRICING



Constructed from S.A.N. plastic (BB-106, 109, 112) or acrylic with 30% rubber (BB-118, 130, 136). A modular system for a variety of applications. Specify color when ordering. Dishwasher safe (BB-106, 109, 112). Hand wash (BB-118, 130, 136).

Case pack: 24 each (BB106), 12 each (BB-109, 112), 1 each (BB- 118, 130, 136).

BB106	6" (15.2 CM)
BB109	9" (22.9 CM)
BB112	12" (30.5 CM)
BB118	18" (45.7 CM)
BB130	30" (76.2 CM)
BB136	36" (91.4 CM)
BT3036	30,36" BOWLS AND LG CUBE
TTONG3W	VERSATILE 3-WAY TONGS

PARTS:

CLEAR	SMOKE	DESCRIPTION
BCCLG	BCSLG	LARGE CUBE (7" X 7" X 10.5")
BCCMD	BCSMD	MEDIUM CUBE (7" X 7" X 9.5")
BCCSM	BCSSM	SMALL CUBE (6" X 6" X 7.5")

BSV8 VELCRO SET



BREAKFAST BAR

3 Tier, mix clear pebbled shell bowls with clear pebbled cubes. (Light box not included)



SALAD BAR

2 Tier, 18" and 36" smoke pebbled shellbowls with large smoke cube, six 9" smoke shell dishes and stack of 6" smoke shell dishes (BB118S, BB136S, BCCLG, six BB109S and one dozen BB106S).



DELI BAR

3 Tier, mix smoke pebbled shell bowls with smoke colored cubes, 7 smoked ,6" shell dishes and 4 clear 12" shell dishes (seven BB106S and four BB112C)



SEAFOOD BAR

36" Clear pebbled shell bowl with a stack of 6" clear shell dishes (BB136C, and one dozen BB106C). (Light box not included)

CARE

Small bowls are dishwasher safe. Large bowls must be hand washed. Large bowls should not be hand carried with ice.

WARRANTY

As a manufacturer of fine products, Service Ideas, Inc. is interested in knowing about any problems you may experience. We will work with you individually to determine if the problem is caused by a manufacturer's defect.



IT3GPL
STAINLESS
3G



IT5GPL
STAINLESS WITH ITSRL LID
5G

BOTH SIZES AVAILABLE IN STAINLESS FINISH

TEA URNS

Constructed from stainless steel with a plastic lid. Features staggered rubber grip handles. Stainless lid sold separately. **Hand wash in pot sink.**

Case pack: 1 each.

IT3GPL	3 GALLON WITH PLASTIC LID 16.75" X 11.25" X 15.5" (41.9 CM X 28.1 CM X 38.8 CM)
IT5GPL	5 GALLON WITH PLASTIC LID 21.75" X 11.25" X 15.5" (54.4 CM X 28.1 CM X 38.8 CM)

PARTS	ITPRL	PLASTIC REPLACEMENT LID FOR IT
	ITSPIG	REPLACEMENT SPIGOT FOR IT3 AND IT5
	ITSRL	STAINLESS STEEL REPLACEMENT LID FOR IT3 AND IT5



URN
POLISHED STAINLESS WITH
BRASS ACCENTS



URNSS
BRUSHED STAINLESS
AVAILABLE BY SPECIAL
ORDER
LEAD TIME 8 WEEKS

3 SIZES AVAILABLE IN BOTH FINISHES

INSULATED URNS

 3 HOUR TEMPERATURE RETENTION

Constructed from stainless steel with foam insulation. The insulation eliminates need for sterno or a plugin. For optimal retention, remove or flip open lid and preheat server with warm water. Empty contents and refill with hot beverage. Secure lid closure. Urn will maintain optimal retention no longer than 2-3 hours. Varying factors that effect temperature are content levels, topping off, open lids. **Hand wash.**

Case pack: 1 each.

URN15	1.5 GALLON 22.5" X 12.5" X 14" (57.2 CM X 31.8 CM X 35.6 CM)
URN30	3 GALLON 25.5" X 14" X 15.5" (64.5 CM X 35.6 CM X 38.1 CM)
URN50	5 GALLON 28.5" X 16" X 17" (72.4 CM X 40.6 CM X 43.2 CM)

PARTS	URN15LID	1.5 GALLON URN LID
	URN30LID	3 GALLON URN LID
	URN50LID	5 GALLON URN LID
	URN15LEG	1.5 GALLON URN STAND
	URN30LEG	3 GALLON URN STAND
	URN50LEG	5 GALLON URN STAND
	URN15GAS	1.5 GALLON URN GASKET
	URN30GAS	3 GALLON URN GASKET
	URN50GAS	5 GALLON URN GASKET
	URNSPIG	REPLACEMENT SPIGOT
	URNPIGGW	REPLACEMENT SPIGOT, GASKET AND WASHER



NUAGE LINE
PAGE 3

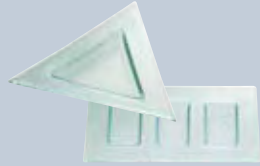

ECO-LINE PLATES
PAGE 4



RAIN DROP
PAGE 5



RICCIOLO
PAGE 6



THERMO-PLATE™
PLATTERS PAGES 10-11



HOT SOLUTIONS™
PAGE 12

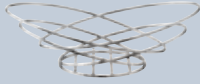

BREAD BASKET
PAGE 13



WINE CHILLER
PAGE 13



TABLE ORGANIZER
PAGE 13



SYRUP BOTTLE
PAGE 14



SYRUP CADDY
PAGE 14



SUGAR/CREAMER SET
PAGE 14



NEW GENERATION™
PAGE 16



PUSH BUTTON
METALLIC PAGE 17



THERMO-SERV®
PAGE 17-18



SWIRL SERVER
PAGE 18



ALFI® JUWEL
PAGES 20 & 29



ALFI® OPAL
PAGES 20 & 28



ALFI® ALBERGO
PAGES 21 & 29



ALFI® HOTELLO
PAGE 21



STAINLESS PITCHER
PAGE 21



PWL STEELVAC™
PAGE 22



S2 STEELVAC™
PAGE 23



BREW N' POUR™
PAGE 24



CLASSIC CARAFE™
PAGES 24 & 31



ALFI® KUGEL BALL
PAGE 25



ALFI® NOMOS
PAGE 26



ALFI® DIANA
PAGE 27



SUGAR/CREAMER
PAGE 29



ALFI® DAN
PAGE 29



PUSH N' SERV™
PAGE 30



ALFI® COFFEE MAKER
PAGE 32



BRICK PRESS
PAGE 32



TEAPOT
PAGE 33



CERAMIC TEAPOT
PAGE 34



TEA CHEST
PAGE 34



TEA BALL
PAGE 36



PLASTIC TEAPOT
PAGE 36



ALFI® COOL BOTTLE
PAGE 37



ICE TUBE PITCHER
PAGE 37



WATER PITCHER
PAGE 38



FROTHING PITCHER
PAGE 38



TRAY
PAGE 39



ICE BUCKET
PAGE 39



FIRST AID KIT
PAGE 39



ECO-AIR® AIRPOTS
PAGE 42-43



GRAVITY-SERV™
PAGE 44



SIGHT GLASS AIRPOT
PAGE 45



PREMIUM GLASS - TES
PAGE 45



AIRPOT COVER-UP
PAGE 47



AIRPOT ROTO RACK
PAGE 47



WIRE RACKS
PAGE 48



CONDIMENT HOLDER
PAGE 49



BREWER PACKAGES
PAGE 50



ZE PÉ BEVERAGE
PAGE 52



ZE PÉ CEREAL
PAGE 53



ZE PÉ TRAY
PAGE 53



ZE PÉ SERVING CARTS
PAGE 54



THERMAL CONTAINER
PAGE 55



TEA URNS
PAGE 57



PRODUCT INDEX
AND PRICING



SERVICE IDEAS, INC. PRODUCT INDEX 2008

PRODUCT INDEX

PAGE	PRODUCT CODE	PRODUCT DESCRIPTION	2008 LIST EACH PRICE	PRODUCT UPC	CASE UPC	CUBE	CASE WT.	CASE QTY
49	00226	FILTER POUCH CLEANR .75OZ 25CT	\$16.00	717996950317	30717996950318	0.31	5.40	4
49	01212	GLASS BOWL CLEANER 12 OZ.	\$5.00	717996950300	30717996950301	0.31	2.20	12
26	0125999100	ALFI NOMOS 1265 REPL GLS LINER	\$34.50	4002458070259	04002458070259	NA	2.00	1
26	0175 010 094	MOD CLASSIC #ISHINY GLS TRANSPAREN	\$58.50	4002458442803	04002458442803	0.19	2.00	1
26	0175 033 094	MOD CLASSIC #ISHINY LAVA RED	\$58.50	4002458442827	04002458442827	0.19	2.00	1
26	0175 052 094	MOD CLASSIC #ISHINY COBALT BLU	\$58.50	4002458442834	04002458442834	0.19	2.00	1
26	0175 970 094	MOD CLASSIC #ISHINY COGNAC	\$58.50	4002458442902	04002458442902	0.19	2.00	1
26	0175 971 094	MOD CLASSIC #1 SHINY ORANGE	\$58.50	4002458442919	04002458442919	0.19	2.00	1
13	0355010000	ALFI BOTTLE COOLER WHITE TRANS	\$61.00	4002458451249	04002458451249	0.20	2.80	1
13	0355051000	ALFI BOTTLE COOLER ICE BLUE	\$61.00	4002458451256	04002458451256	0.20	2.80	1
21	0767000060	ALBERGO .6 LTR S/S VACUUM	\$105.80	4002458445248	04002458445248	0.14	1.80	1
21	0767000100	ALBERGO 1 LTR S/S VACUUM	\$131.50	4002458445224	04002458445224	0.16	2.00	1
21	0767000150	ALBERGO 1.5 LTR S/S VACUUM	\$142.70	4002458445231	04002458445231	0.21	2.40	1
21	0767000200	ALBERGO 2 LTR S/S VACUUM	\$148.20	4002458445255	04002458445255	0.25	3.00	1
26	0915020100	ALFI TOSCANA 1L BLACK	\$50.50	4002458446252	04002458446252	0.26	2.00	1
26	0915026100	ALFI TOSCANA 1L SILVER	\$50.50	4002458446276	04002458446276	0.26	2.00	1
26	0915051100	ALFI TOSCANA 1L COBALT BLUE	\$50.50	4002458446283	04002458446283	0.26	2.00	1
26	0915053100	ALFI TOSCANA 1L LIGHT BLUE	\$50.50	4002458446290	04002458446290	0.26	2.00	1
26	0915999100	ALFI TOSCANA 1L GLASS LINER	\$35.00	4002458447327	04002458447327	0.14	1.00	1
27	0925037100	DIANA 1 LITER RED	\$32.00	4002458453946	04002458453946	0.25	1.80	1
27	0925062100	DIANA 1 LITER BLUE	\$32.00	4002458453908	04002458453908	0.25	1.80	1
27	0925073100	DIANA 1 LITER LIME	\$32.00	4002458453922	04002458453922	0.25	1.80	1
27	0925096100	DIANA 1 LITER YELLOW	\$32.00	4002458453915	04002458453915	0.25	1.80	1
27	0925109100	DIANA 1 LITER ORANGE	\$32.00	4002458449611	04002458449611	0.25	1.80	1
29	0930270100	DAN 1L ALUM LACQR SATIN SILVER	\$150.40	4002458451300	04002458451300	0.25	2.65	1
29	0935999100	DAN 1L REPLACEMENT LINER	\$42.50	4002458452000	04002458452000	NA	2.00	1
29	0937205100	DAN 1L STAINLESS MAT FINISH	\$190.60	4002458451294	04002458451294	0.25	2.65	1
33	1000CC	COFFEE PRESS 33 OZ	\$48.10	717996224906	30717996224907	2.20	22.00	12
33	1000CCG	COFFEE PRESS 33-8 OZ GOLD	\$54.80	717996224944	30717996224945	2.20	22.00	12
26	105L	FROSTED BALL GLASS LINER	\$26.60	4002458130106	04002458130106	0.12	1.00	1
39	1124SI	FIRST AID SUPPLY KIT - 173 PCS	\$67.10	717996015122	30717996015123	4.84	54.40	24
39	1130SI	FIRST AID SUPPLY KIT - 30 PCS	\$11.00	717996015504	30717996015505	1.38	28.00	132
37	1135010075	ALFI COOL BOTTLE .75LTR WHITE	\$36.10	4002458451393	04002458451393	0.16	1.50	1
37	1135033075	ALFI COOL BOTTLE .75LTR RED	\$36.10	4002458451409	04002458451409	0.16	1.50	1
37	1135970075	ALFI COOL BOTTLE .75LTR ICETEA	\$36.10	4002458451423	04002458451423	0.16	1.50	1
37	1135971075	ALFI COOL BOTTLE .75LTR ORANGE	\$36.10	4002458451430	04002458451430	0.16	1.50	1
37	1135974075	ALFI COOL BOTTLE.75L WATER BLU	\$36.10	4002458451447	04002458451447	0.16	1.50	1
37	1135999075	ALFI COOLBOTTLE REPL GLASS LIN	\$19.60	4002458453298	04002458453298	0.00	0.40	1
26	115E	FROSTED BALL .9L BLACK	\$47.60	4002458068126	04002458068126	0.21	2.00	1
26	115KC	FROSTED BALL .9L COBALT BLUE	\$47.60	4002458070426	04002458070426	0.21	2.00	1
26	115PA	FROSTED BALL .9L WHITE	\$47.60	4002458068232	04002458068232	0.21	2.00	1
26	115PP	FROSTED BALL .9L ANTHRACITE	\$47.60	4002458068072	04002458068072	0.21	2.00	1
26	115SV	FROSTED BALL .9L SILVER	\$47.60	4002458428722	04002458428722	0.21	2.00	1
6	1200CL	IMPILABILI PIATTO RECT 12"	\$25.20	717996019007	30717996019008	NA	NA	NA
6	1201CL	IMPILABILI PIATTO RECT 10.25"	\$22.10	717996019014	30717996019015	NA	NA	NA
49	12632	ESPRESSO MACHINE CLEANER 32 OZ	\$19.30	717996950331	30717996950332	0.37	13.40	6
26	1265010100	ALFI NOMOS 1L WHITE GLASS LND	\$75.60	4002458444425	04002458444425	0.22	3.00	1
26	1265020100	ALFI NOMOS 1L BLACK GLASS LND	\$75.60	4002458444449	04002458444449	0.22	3.00	1
26	1265030100	ALFI NOMOS 1L RED GLASS LND	\$75.60	4002458444401	04002458444401	0.22	3.00	1
26	1265050100	ALFI NOMOS 1L BLUE GLASS LND	\$75.60	4002458444739	04002458444739	0.22	3.00	1
49	12732	FROTHER & WAND CLEANER 32 OZ.	\$19.30	717996950348	30717996950349	0.35	13.60	6
49	12806	ESPRESSO MACHINE TABLETS 100CT	\$28.00	613933128019	06139331280190	0.35	5.00	1
35	1300W	COSY .5L TEA POT W/COVER	\$67.10	717996239511	30717996239512	2.26	21.00	8
35	1300WBODY	COSY .6 L BODY ONLY	\$24.10	717996239702	30717996239703	NA	NA	1
35	1300WLID	COSY .6L WHITE LID ONLY	\$16.80	717996239719	30717996239710	NA	NA	1
35	1301W	COSY .9L TEA POT W/COVER	\$83.80	717996239528	30717996239529	2.26	26.00	8
35	1302W	COSY 1.3L TEA POT W/COVER	\$100.60	717996239535	30717996239536	2.84	31.60	8
35	1417W	COSY SUGAR BOWL WHITE (6oz.)	\$26.40	717996239597	30717996239598	1.52	21.00	32
35	1418W	COSY CREAMER WHITE	\$26.40	717996239603	30717996239604	1.75	21.00	32
6	1406CL	QUARDO PIATTO SQUARE 11.75	\$29.00	717996019021	30717996019022	NA	NA	NA
29	1432IL	ALBERGO 1L REPLACEMENT LINER	\$39.60	4002458427534	04002458427534	0.12	1.00	1
29	1432LID	ALBERGO LID .65 & 1 & 1.5L	\$17.80	717996990030	30717996990031	0.26	2.00	12
29	1442 999 150	ALBERGO GLASS LINER 1.5L	\$40.60	717996960019	30717996960010	0.15	2.00	1
29	14421	ALBERGO II 1L W/O TEA FILTER	\$84.60	4022458430220	04022458430220	0.24	3.00	1
29	144215	ALBERGO II 1.5L W/O TEA FILTER	\$97.20	4002458430244	04002458430244	0.39	3.26	1
29	144265	ALBERGO II .65L W/O TEA FILTER	\$78.30	4002458430350	04002458430350	0.11	1.00	1
29	1442999070	ALBERGO GLASS LINER .7L	\$33.60	4002458435843	04002458435843	0.11	2.00	1
27	145G	HANDY GLASS LINER .6 LITER	\$23.10	4002458072697	04002458072697	0.06	1.00	1
33	1500CC	COFFEE PRESS 50-7 OZ	\$61.60	717996225002	30717996225003	3.09	29.40	12
33	1500CCG	COFFEE PRESS 50-7 OZ GOLD	\$68.30	717996224678	30717996224679	3.09	29.40	12
35	1505W	COSY MANTO .6L TEA POT W/COVER	\$56.90	717996239542	30717996239543	2.22	21.00	8

PAGE	PRODUCT CODE	PRODUCT DESCRIPTION	2008 LIST EACH PRICE	PRODUCT UPC	CASE UPC	CUBE.	CASE WT.	CASE QTY
35	1505WBODY	COSY MANTO .6L BODY ONLY	\$19.30	717996239641	30717996239642	NA	NA	1
35	1505WJACKET	COSY MANTO .6L JACKET ONLY	\$30.40	717996239658	30717996239659	NA	NA	1
35	1505WLID	COSYMANTO LID ONLY F/1505,3505	\$8.40	717996239665	30717996239666	NA	NA	1
35	1510W	COSY MANTO 1L TEA POT W/COVER	\$63.80	717996239559	30717996239550	2.22	25.80	8
35	1510WBODY	COSY MANTO 1L BODY ONLY	\$23.00	717996239672	30717996239673	NA	NA	1
35	1510WJACKET	COSY MANTO 1L JACKET ONLY	\$32.80	717996239689	30717996239680	NA	NA	1
35	1510WLID	COSY MANTO LID F/1510W & 3510W	\$9.90	717996239696	30717996239697	NA	NA	1
26	165E	FROSTED BALL .9L W/PBL BLACK	\$51.00	4002458078316	04002458078316	0.19	2.00	1
26	165KC	FROST BALL .9L W/PBL CBT BLUE	\$51.00	4002458078330	04002458078330	0.19	2.00	1
26	165PA	FROSTED BALL .9L W/PBL WHITE	\$51.00	4002458078361	04002458078361	0.19	2.00	1
26	165PP	FROST BALL .9L W/PBL ANTHRACI	\$51.00	4002458430947	04002458430947	0.19	2.00	1
26	165SV	FROSTED BALL .9L W/PBL SILVER	\$51.00	4002458428739	04002458428739	0.19	2.00	1
6	1801CL	NUVOLA ANTIPASTA 3 COMPARTMENT 16"	\$27.40	717996019038	3071799619039	NA	NA	NA
6	1802CL	NUVOLA ANTIPASTA 2 COMPARTMENT 11.5"	\$22.10	717996019045	3071799619046	NA	NA	NA
6	1803CL	NUVOLA ANTIPASTA 4 COMPARTMENT 11"	\$29.00	717996019052	3071799619053	NA	NA	NA
28	18521	SAPHIR 1 LITER CHROME	\$301.80	4002458185250	04002458185250	0.24	3.00	1
28	185265	SAPHIR .65 LITER CHROME	\$293.60	4002458185236	04002458185236	0.19	3.00	1
28	185L1	SAPHIR/ACHAT GLASS LINER 1L	\$89.20	4002458131714	04002458131714	0.11	2.00	1
28	185L65	SAPHIR/ACHAT LINER .65 LITER	\$79.80	4002458130045	04002458130045	0.11	2.00	1
27	1915010060	NEAT .6 LITER WHITE	\$42.60	4002458453854	04002458453854	0.16	1.20	1
27	1915010100	NEAT 1 LITER WHITE	\$46.00	4002458453243	04002458453243	0.25	1.80	1
27	1915010150	NEAT 1.5 LITER WHITE	\$47.30	4002458453861	04002458453861	NA	NA	1
6	2100CL	MAXI IMPILABILI 17.75"	\$49.50	717996019069	3071799619060	NA	NA	NA
33	2109060040	ALFI 21 TEA POT.6 LT 4 CUP S/	\$116.00	4002458449291	4002458449291	NA	NA	1
33	2109 140 040	ALFI 21 TEA POT 1.4L 11 CUP S/	\$127.70	4002458444814	04002458444814	0.15	2.00	1
32	2120 050 040	ALFI 21 COFFEE MAKR .5 L DBL S	\$123.10	4002458444807	04002458444807	0.08	2.00	1
32	2120 120 040	ALFI 21 COFFEE MAKR 1.2L DBL S	\$161.00	4002458444791	04002458444791	0.14	3.00	1
29	2121260800	ALFI JUWEL CREAMER/SUGAR	\$54.10	4002458446030	04002458446030	0.04	1.00	1
54	33030400x	ZEPE PARIS TROLLEY	\$3,936.30	NA	NA	18.70	90.00	1
35	3505W	COSY MANTO .6 LTR W/MATT COVER	\$56.90	717996239566	30717996239567	2.26	20.80	8
33	350CC	COFFEE PRESS 3 CUP 12 OZ	\$28.30	717996224876	30717996224877	3.36	36.00	36
33	350CCG	COFFEE PRESS 3 CUP12 OZ GOLD	\$33.10	717996224913	30717996224914	3.36	36.00	36
35	3510W	COSY MANTO 1 LTR W/MATT COVER	\$63.80	717996239504	30717996239505	2.30	26.00	8
	37030020x	ZEPE 2 LVL ROMA TROLLEY	\$1,806.00	NA	NA	5.30	52.00	1
	37030030x	ZEPE 3 LVL ROMA TROLLEY	\$2,125.10	NA	NA	5.30	69.40	1
49	40647	ACTIVATED DESCALING CLEANR 7OZ	\$5.30	717996950324	30717996950325	0.31	11.20	24
54	43040400x	ZEPE PARIS TOP BAR	\$2,044.70	NA	NA	NA	NA	1
54	43060403x	ZEPE PARIS TOP DESSERT	\$3,476.70	NA	NA	NA	NA	1
54	43070403x	ZEPE PARIS TOP REFRIG	\$2,044.70	NA	NA	NA	NA	1
54	43090400x	ZEPE PARIS TOP CHEESE	\$2,044.70	NA	NA	NA	NA	1
53	50303453	ZEPE RECTANGULAR ICE PACK	\$65.00	717996274345	30717996274346	NA	NA	1
21	55710	HOTELLO 1L TOP THERM S/S LINED	\$144.30	4002458418051	04002458418051	0.14	3.00	1
21	55715	HOTELLO 1.5L TOP THERM S/S LIN	\$153.10	4002458418068	04002458418068	0.17	3.00	1
21	55730	HOTELLO .3L TOP THERM S/S LINE	\$99.10	4002458418044	04002458418044	0.09	2.00	1
21	55760	HOTELLO .6L TOP THERM S/S LINE	\$135.20	4002458420535	04002458420535	0.20	2.00	1
20	571LID	JUWEL/OPAL LID AND HINGE	\$42.30	717996224104	30717996224105	NA	NA	1
29	57210	JUWEL 1 LITER CHROME	\$301.80	4002458572050	04002458572050	0.20	3.00	1
29	57215	JUWEL 1.50 LTR CHROME VACUUM	\$329.60	4002458572074	04002458572074	0.30	4.00	1
29	5725	JUWEL .5 LTR CHROME	\$226.00	4002458572036	04002458572036	0.14	2.00	1
20	572GAS	JUWEL 1-2LTR LINER GASKET	\$3.30	717996224142	30717996224143	0.00	0.01	1
20	57715	JUWEL 1.5L CH W/SS VAC LINER	\$408.90	4002458577079	04002458577079	0.30	4.00	1
27	57G	HANDY 1L GLASS LINER	\$27.10	4002458130052	04002458130052	0.10	1.00	1
28	57L1	JUWEL/OPAL/HANDY LINER 1 LTR	\$89.20	717996224210	30717996224211	0.10	1.00	1
28	57L15	JUWEL/OPAL 1.5 LTR GLASS LINER	\$93.80	4002458130076	04002458130076	0.17	2.00	1
28	57L2	JUWEL/OPAL 2 LTR GLASS LINER	\$117.30	717996224234	30717996224235	0.21	2.00	1
29	57L5	JUWEL/OPAL .5 LTR GLASS LINER	\$68.50	717996224258	30717996224259	0.07	1.00	1
28	57L65	JUWEL/OPAL .65 LTR GLASS LINER	\$71.20	717996224265	30717996224266	0.11	1.00	1
28	57LGAS	57 ALFI LINER GASKET	\$3.30	717996224289	30717996224280	NA	0.01	1
33	600CC	COFFEE PRESS 4 CUP CHROME	\$33.80	717996224883	30717996224884	1.74	17.00	12
33	600CCG	COFFEE PRESS 4 CUP GOLD	\$42.50	717996224920	30717996224921	1.74	17.00	12
38	60721	TAYLOR THERM NSF 0/220F 5"	\$31.60	717996001019	30717996001010	NA	0.05	1
28	6921	OPAL 1L CHROME GLASS LINED	\$301.80	4002458692055	04002458692055	0.20	3.00	1
28	69215	OPAL 1.5L CHROME GLASS LINED	\$329.60	4002458692079	04002458692079	0.31	5.00	1
28	6922	OPAL 2L CHROME GLASS LINED	\$396.60	4002458692086	04002458692086	0.33	5.00	1
28	69265	OPAL .65L CHROME GLASS LINED	\$293.60	4002458692031	04002458692031	0.14	3.00	1
20	69715	OPAL 1.5L TOP THERM S/S LINED	\$408.90	4002458697074	04002458697074	0.33	3.80	1
3	708343BRN	ESPRESSO CUP NUAGE BROWN	\$9.40	717996017096	30717996017097	0.12	2.00	6
3	708343WH	ESPRESSO CUP NUAGE WHITE	\$9.40	717996017072	30717996017073	0.12	2.00	6
3	7083CL	ESPRESSO CUP CLEAR	\$9.40	717996017065	30717996017066	0.12	2.00	6
3	708443BRN	CAPPUCCINO CUP NUAGE BROWN	\$13.00	717996017461	30717996017462	NA	NA	48
3	708443WH	CAPPUCCINO CUP NUAGE WHITE	\$13.00	717996017546	30717996017547	NA	NA	48

PAGE	PRODUCT CODE	PRODUCT DESCRIPTION	2008 LIST EACH PRICE	PRODUCT UPC	CASE UPC	CUBE	CASE WT.	CASE QTY
3	7084CL	CAPPUCCINO CUP CLEAR	\$13.00	717996017447	30717996017448	NA	NA	48
3	708543BRN	ESPRESSO SAUCER NUAGE BROWN	\$7.10	717996017140	30717996017141	0.07	1.60	6
3	708543WH	ESPRESSO SAUCER NUAGE WHITE	\$7.10	717996017126	30717996017127	0.07	1.60	6
3	7085CL	ESPRESSO SAUCER CLEAR	\$7.10	717996017119	30717996017110	0.07	1.60	6
3	708643BRN	CAPPUCCINO SAUCER NUAGE BROWN	\$11.10	717996017478	30717996017479	NA	NA	48
3	708643WH	CAPPUCCINO SAUCER NUAGE WHITE	\$11.10	717996017553	30717996017554	NA	NA	48
3	7086CL	CAPPUCCINO SAUCER CLEAR	\$11.10	717996017454	30717996017455	NA	NA	48
5	7114CL	RAIN RECTANGLE 11.75X7.8 CLR	\$22.20	717996017805	30717996017806	0.38	14.40	6
5	7134CL	RAIN OVAL 9.5 X 7.5 CLEAR	\$10.40	717996017812	30717996017813	0.41	16.00	12
5	7135CL	RAIN OVAL 12 X 10.25 CLEAR	\$12.20	717996017829	30717996017820	0.67	24.80	12
5	7138CL	RAIN RECTANGLE 9.75X6.25 CLEAR	\$20.20	717996017836	30717996017837	0.26	10.80	6
5	7139CL	RAIN RECTANGLE 7.5 X 5 CLEAR	\$15.00	717996017843	30717996017844	0.16	6.80	6
5	7140CL	RAIN RECTANGLE 6 X 4 CLEAR	\$11.20	717996017850	30717996017851	0.16	8.00	12
5	7211CL	RAIN DROP 9 X 8 CLEAR	\$10.40	717996017867	30717996017868	0.10	8.00	6
5	7212CL	RAIN DROP 11.25X9.75 CLEAR	\$12.20	717996017874	30717996017875	0.30	12.80	6
5	7215CL	RAIN DROP 8.8 X 7.8 CLEAR	\$10.40	717996017881	30717996017882	0.19	8.00	6
5	7216CL	RAIN DROP 7.5 X 6.5 CLEAR	\$9.80	717996017898	30717996017899	0.17	6.20	6
5	7217CL	RAIN DROP 3.25 X 3 CLEAR	\$5.50	717996017904	30717996017905	0.12	3.00	12
5	7225CL	RAIN ROUND 10.6 CLEAR	\$9.60	717996017911	30717996017912	0.77	21.60	12
5	7226CL	RAIN ROUND 8.25 CLEAR	\$8.10	717996017928	30717996017929	0.54	15.80	12
5	7270CL	RAIN SQUARE COUPE 8.6 CLEAR	\$11.50	717996017935	30717996017936	0.51	15.20	12
5	7272CL	RAIN SQUARE COUPE 10.6 CLEAR	\$15.00	717996017959	30717996017950	0.79	21.50	12
5	7273CL	RAIN SQUARE COUPE 12.75 CLEAR	\$21.30	717996017966	30717996017967	0.63	18.60	6
6	7245IV	RICCIOLO 8.25 " IVORY	\$11.50	717996018031	30717996018032	NA	NA	NA
6	7246IV	RICCIOLO 10.6 " IVORY	\$13.80	717996018048	30717996018049	NA	NA	NA
6	7247IV	RICCIOLO 12.5 " IVORY	\$21.20	717996018055	30717996018056	NA	NA	NA
6	7344CL	METROPOLIS 6" ROUND	\$7.70	717996018062	30717996018063	NA	NA	NA
6	7348CL	METROPOLIS 14.6" ROUND	\$19.90	717996018260	30717996018261	NA	NA	NA
6	7350CL	METROPOLIS 9.2" X 7.5" OVAL	\$11.00	717996018109	30717996018100	NA	NA	NA
6	7355CL	METROPOLIS TUMBLER 10 OZ	\$6.20	717996018116	30717996018117	NA	NA	NA
6	7358CL	METROPOLIS 12" CENTERPIECE	\$18.90	717996018123	30717996018124	NA	NA	NA
6	7367CL	METROPOLIS 5.5" SQUARE	\$7.40	717996018130	30717996018131	NA	NA	NA
21	767LID	ALBERGO TOP THERM LID	\$17.20	4002458446184	04002458446184	0.26	1.20	12
7	8001BLU	COLORS LINE 12.5" BLUE 2	\$17.10	717996011186	30717996011187	0.60	16.80	6
7	8001CLR	COLORS LINE 12.5" CLEAR	\$17.10	717996010004	30717996010005	0.60	16.80	6
3	8003221BLU	NUAGE SATIN 12.5" BLUE	\$28.70	717996011193	30717996011194	0.74	19.00	6
3	8003221GRN	NUAGE SATIN 12.5" GREEN	\$28.70	717996011209	30717996011200	0.60	17.80	6
3	8003221GRY	NUAGE SATIN 12.5" GRAY	\$28.70	717996011216	30717996011217	0.60	17.80	6
3	8003221WH	NUAGE SATIN 12.5" WHITE	\$28.70	717996011230	30717996011231	0.60	17.80	6
3	800343BLU	NUAGE SHINY 12.5" BLUE	\$23.90	717996010080	30717996010081	0.74	18.00	6
3	800343GRN	NUAGE SHINY 12.5" GREEN	\$23.90	717996010097	30717996010098	0.60	18.80	6
3	800343GRY	NUAGE SHINY 12.5" GRAY	\$23.90	717996010104	30717996010105	0.60	18.80	6
3	800343WH	NUAGE SHINY 12.5" WHITE	\$23.90	717996010127	30717996010128	0.60	18.80	6
7	8003BLU	COLORS PEBBLE 12.5" BLUE 2	\$18.80	717996010134	30717996010135	0.60	19.00	6
7	8003CL	COLORS PEBBLED 12.5" CLEAR	\$18.80	717996010141	30717996010142	0.60	19.00	6
3	8009221BLU	NUAGE SATIN 13.375 BLUE	\$28.70	717996010158	30717996010159	0.74	20.00	6
3	8009221GRN	NUAGE SATIN 13.375 GREEN	\$28.70	717996010165	30717996010166	0.60	19.60	6
3	8009221GRY	NUAGE SATIN 13.375" GRAY	\$28.70	717996010172	30717996010173	0.60	19.60	6
3	8009221WH	NUAGE SATIN 13.375" WHITE	\$28.70	717996010196	30717996010197	0.60	19.60	6
3	800943BLU	NUAGE SHINY 13.75" BLUE	\$23.90	717996010202	30717996010203	0.07	22.00	6
3	800943GRN	NUAGE SHINY 13.75" GREEN	\$23.90	717996010219	30717996010210	0.60	19.40	6
3	800943GRY	NUAGE SHINY 13.375" GRAY	\$23.90	717996010226	30717996010227	0.60	19.40	6
3	800943WH	NUAGE SHINY 13.75" WHITE	\$23.90	717996010240	30717996010241	0.60	19.40	6
33	800CC	COFFEE PRESS 6 CUP 27 OZ	\$43.20	717996224890	30717996224891	2.12	20.00	12
33	800CCG	COFFEE PRESS 6 CUP 27 OZ GO	\$49.30	717996224937	30717996224938	2.12	20.00	12
53	80700610	ZEPE SINGLE 3L CEREAL DISPENSER	\$463.50	717996270262	30717996270263	1.68	8.20	1
53	80700620	ZEPE DOUBLE 3 L CEREAL DISP	\$834.30	717996270279	30717996270270	NA	NA	1
52	80702690	ZEPE DBL SS 7L JUICE DISPENSER	\$906.40	717996270286	30717996270287	3.82	20.30	1
52	80702700	ZEPE SNGL SS 7L JUICE DISPENSE	\$473.80	717996270293	30717996270294	2.75	12.20	1
52	80702710	ZEPE DBL SS 4L JUICE DISPENSER	\$793.10	717996270309	30717996270300	3.50	16.40	1
52	80702720	ZEPE SNGL SS 4L JUICE DISPENSE	\$463.50	717996270316	30717996270317	NA	7.10	1
7	8123301CL	FRUTTI MARE COUPE 12.5" CL SAT	\$27.20	717996010295	30717996010296	0.60	18.60	6
7	8123BLU3	FRUTTI MARE COUPE 12.5" BLUE 3	\$21.00	717996012367	30717996012368	0.60	18.60	6
7	8123CL	FRUTTI MARE COUPE 12.5"SHY CLR	\$21.00	717996010318	30717996010319	0.60	18.60	6
7	8130CL	TRIANGLE 12.5" SATIN	\$30.10	717996010363	30717996010364	0.7	16.00	6
7	8130201SA	TRIANGLE 12.5" SATIN	\$30.10	717996010356	30717996010357	0.60	14.20	6
8	8143CL	SQUARE SHINY 12" CLEAR	\$27.40	717996010400	30717996010401	0.61	18.00	6
38	8216	TAYLOR BI-THERM DIAL 8" O/220F	\$50.20	717996001026	30717996001027	0.04	0.15	1
26	865010	BASIC MODERN .9L TRANSPARENT	\$83.80	4002458437793	04002458437793	0.26	2.00	1
26	865L	BASIC MODERN LINER .9L	\$34.00	4002458131103	04002458131103	0.12	1.00	1
26	865PB	BASIC MODERN .9L LAVA RED	\$83.80	717996224906	04002458065651	0.26	2.00	1

PAGE	PRODUCT CODE	PRODUCT DESCRIPTION	2008 LIST EACH PRICE	PRODUCT UPC	CASE UPC	CUBE.	CASE WT.	CASE QTY
26	865PC	BASIC MODERN .9L AZURE BLUE	\$83.80	717996224920	04002458065750	0.26	2.00	1
26	865PP	BASIC MODERN .9L ANTHRACITE	\$83.80	717996224937	04002458065507	0.26	2.00	1
8	8789CL	FISH EYE 19.5x9.5" CLEAR	\$49.90	717996010516	30717996010517	1.15	20.00	6
8	8866CL	FISH EYE 12x7.5" CLEAR	\$19.90	717996010530	30717996010531	0.56	14.60	6
7	8880/221WH	CAKE STAND 10.625" NUAGE WHITE	\$29.80	717996010578	30717996010579	0.46	3.00	1
7	8880/43WH	CAKE STAND 10.625" NUAGE WHITE	\$29.80	717996010592	30717996010593	0.46	3.00	1
7	8880CL	CAKE STAND 10.625" CLEAR	\$29.80	717996010615	30717996010616	0.46	3.00	1
8	8948202SA	GOUR PASTA BOWL SATIN 7.5" CLR	\$19.80	717996010738	30717996010739	0.34	5.20	6
8	8949202SA	GOURMET BOWL SATIN 11.75" CLR	\$30.70	717996010660	30717996010661	0.58	12.00	6
8	8950202SA	GOURMET BOWL SATIN 12.5" CLEAR	\$47.00	717996010677	30717996010678	0.97	12.80	6
8	8951202CL	GOURMET PLATE 12.5" CLEAR SATN	\$27.60	717996017249	30717996017240	0.60	19.40	6
27	9103010065	REPLACEMENT LID FOR ALFI NEAT	\$9.20					
27	9103020056	NOMOS REPLACMENT LID BLACK	\$7.30	4002458445712	04002458445712	NA	0.05	1
25	9103020059	TOSCANA REPL LID BLACK	\$11.70	4002458447358	04002458447358	0.26	1.20	12
25	9103026059	TOSCANA REPL LID SILVER	\$11.70	4002458447365	04002458447365	0.26	1.20	12
25	9103051059	TOSCANA REPL LID COBALT BLUE	\$11.70	4002458447372	04002458447372	0.26	1.20	12
25	9103053059	TOSCANA REPL LID LIGHT BLUE	\$11.70	4002458447389	04002458447389	0.26	1.20	12
29	9103211064	DAN REPLACEMENT LID	\$39.00	4002458453021	04002458453021	NA	0.40	1
27	9352A	HANDY REPL LID WHITE .6 & 1L	\$10.10	NA	04002458074783	0.26	2	12
27	9352E	HANDY REPL LID BLACK .6 & 1L	\$10.10	NA	04002458074776	0.26	2	12
27	9352OT	HANDY ORANGE TAB	\$1.00	717996224302	30717996224303	NA	NA	1
27	9404	HANDY LID GASKET	\$2.30	4002458074752	04002458074752	NA	0.01	1
4	9502 ECO LINE	ECO-LINE SQUARE 9-7/8"	\$21.30	717996011315	30717996011316	0.33	12.80	6
4	9504 ECO LINE	ECO-LINE SQUARE 12-1/4"	\$31.80	717996011124	30717996011125	0.52	19.60	6
4	9506 ECO LINE	ECO-LINE TRAY 4 x 7.875"	\$16.80	717996011049	30717996011040	0.36	8.80	12
4	9507 ECO LINE	ECO-LINE TRAY 6 x 9.875"	\$19.40	717996011056	30717996011057	0.27	8.00	6
4	9509 ECO LINE	ECO-LINE TRAY 8.25 x 13.75"	\$28.90	717996011025	30717996011026	0.36	15.20	6
4	9511 ECO LINE	ECO-LINE TRIANGLE 11"	\$27.60	717996011346	30717996011347	0.47	7.80	6
4	9515 ECO LINE	ECO-LINE SQUARE 4-3/4"	\$11.10	717996011131	30717996011132	0.18	6.00	12
4	9520 ECO LINE	ECO-LINE 3 COMP 15.75 x 7.5"	\$39.40	717996011100	30717996011101	0.56	15.60	6
4	9521 ECO LINE 3 CMP	ECO-LINE 3 COMP 9.875 x 6"	\$22.30	717996011117	30717996011118	0.24	8.00	6
4	9522 ECO LINE	ECO-LINE TRIANGLE 8-1/4"	\$18.40	717996011407	30717996011408	0.45	8.40	12
47	APC22	AIRPOT COVER-UP FOR 2.2L PUMP	\$373.30	717996232214	30717996232215	4.23	40.00	4
47	APC22CH	AIRPOT COV-UP 2.2 LTR ALL CHRO	\$373.30	717996232512	30717996232513	4.40	10.00	1
47	APC22PL	AIRPOT COVERUP LID 2.2L PUMP	\$98.80	717996232239	30717996232230	NA	1.60	1
47	APC22PLCH	ECOPUMP CHROME COVER-UP LID	\$98.80					
47	APCL22	AIRPOT COVER-UP FOR 2.2L LEVER	\$373.30	717996232222	30717996232223	4.28	39.20	4
47	APCL22CH	2.2 AP COVERUP W/LEVR ALL CHRM	\$373.30	717996233663	30717996233664	5.32	42.00	4
47	APCLL	AIRPOT COVERUP LID 2.2L LEVER	\$94.10	717996233625	30717996233626	NA	1.60	1
47	APCLLCH	AP COVERUP LID 2.2L LEVR CHROM	\$98.80	717996233694	30717996233695	6.12	30.00	4
47	APCLTS	AIRPOT CVRUP 2.5L+ LVR TES/SSA	\$509.90	717996233656	30717996233657	5.93	49.20	4
47	APCLTSCH	AP COVERUP F/TES/SSA LVR CHROM	\$509.90	717996233687	30717996233688	5.93	49.20	4
47	APCTS	AIRPOT CVRUP 2.5L+ PMP TES/SSA	\$509.90	717996233632	30717996233633	6.12	48.00	4
47	APCTSCH	AP COVERUP F/TES/SSA PMP CHROM	\$509.90	717996233670	30717996233671	6.12	48.00	4
47	APCTSCHLID	AP COVERUP LID PUMP ALL CHROME	\$120.00	717996233724	30717996233725	NA	1.60	1
47	APCTSLID	PREMIUM AIRPOT COVER LID PUMP	\$120.00	717996239078	30717996239079	NA	1.60	1
47	APCTSLL	PREMIUM AIRPOT COVER LID LEVER	\$120.00	717996239085	30717996239086	NA	1.60	1
47	APCTSLLCH	PREM AP COVERUP LID LEVR CHROME	\$120.00	717996233700	30717996233701	6.12	30.00	4
48	APR2BLC	AIRPOT RACK W/DRIP TRAY DOUBLE	\$75.00	717996231003	30717996231004	1.66	4.60	1
48	APR3BLC	AIRPOT RACK W/DRIP TRAY TRIPLE	\$87.50	717996231027	30717996231028	2.73	7.40	1
48	APRR2BL	AIRPOT RACK DBL ROUND W/TRAYS	\$87.30	717996231072	30717996231073	2.48	6.80	1
48	APS1CBL	AIRPOT RACK W/3 CONDIMENT STANDS	\$209.00					
48	APS2BL	AIRPOT RACK DBL	\$157.00					
37	AWP19SB	ACRYLIC PITCHER 1.9L SMOOTH	\$21.80	717996274239	30717996274230	1.79	11.60	6
37	AWP24BS	ACRYLIC PITCHER 2.4L BELL SHAP	\$24.60	717996274161	30717996274162	2.29	14.80	6
37	AWP33RB	ACRYLIC PITCHER 3.3L RIB BODY	\$27.30	717996274178	30717996274179	2.29	14.80	6
37	AWP33SB	ACRYL PITCHER 3.3L SMOOTH BODY	\$27.30	717996274185	30717996274186	2.29	14.80	6
37	AWPICE	REPL ICE TUBE FOR AWP/PWP'S	\$3.60	717996274208	30717996274209	1.63	26.60	100
37	AWPLI	REPL LID FOR P/AWP 2.4L & 3.3L	\$7.70	717996274192	30717996274193	3.88	31.80	100
37	AWPLI19	REPL LID/COVER FOR P/AWP 1.9L	\$7.40	717996274321	30717996274322	2.61	26.40	100
56	BB106C	SCULPTURED ICE 6 INCH CLEAR SH	\$4.70	717996450343	30717996450344	0.23	4.20	24
56	BB106P	SCULPTURED ICE 6 INCH PEARL SH	\$4.70	717996450350	30717996450351	0.23	4.20	24
56	BB106S	SCULPTURED ICE 6 INCH SMOKE SH	\$4.70	717996450336	30717996450337	0.23	4.20	24
56	BB109C	SCULPTURED ICE 9 INCH CLEAR SH	\$6.10	717996452347	30717996452348	0.40	5.20	12
56	BB109P	SCULPTURED ICE 9 INCH PEARL SH	\$6.10	717996452354	30717996452355	0.40	5.20	12
56	BB109S	SCULPTURED ICE 9 INCH SMOKE SH	\$6.10	717996452330	30717996452331	0.40	5.20	12
56	BB112C	SCULPTURED ICE 12 INCH CLEAR S	\$7.80	717996454341	30717996454342	0.44	7.40	12
56	BB112P	SCULPTURED ICE 12 INCH PEARL S	\$7.80	717996454358	30717996454359	0.44	7.40	12
56	BB112S	SCULPTURED ICE 12 INCH SMOKE S	\$7.80	717996454334	30717996454335	0.44	7.40	12
56	BB118C	SCULPTURED ICE 18 INCH CLEAR B	\$49.70	717996456345	30717996456346	0.58	1.40	1
56	BB118S	SCULPTURED ICE 18 INCH SMOKE B	\$49.70	717996456338	30717996456339	0.58	1.40	1

PAGE	PRODUCT CODE	PRODUCT DESCRIPTION	2008 LIST EACH PRICE	PRODUCT UPC	CASE UPC	CUBE	CASE WT.	CASE QTY
56	BB130C	SCULPTURED ICE 30 INCH CLEAR B	\$132.20	717996458349	30717996458340	2.78	6.60	1
56	BB130S	SCULPTURED ICE 30 INCH SMOKE B	\$132.20	717996458332	30717996458333	2.78	6.60	1
56	BB136C	SCULPTURED ICE 36 INCH CLEAR B	\$144.60	717996459346	30717996459347	4.50	9.80	1
56	BB136S	SCULPTURED ICE 36 INCH SMOKE B	\$144.60	717996459339	30717996459330	4.50	9.80	1
56	BCCLG	CLEAR CUBE LARGE	\$37.40	717996449941	30717996449942	NA	NA	NA
56	BCCMD	CLEAR CUBE MEDIUM	\$37.40	717996449842	30717996449843	NA	NA	NA
56	BCCSM	CLEAR CUBE SMALL	\$37.40	717996449743	30717996449744	NA	NA	NA
56	BCSLG	SMOKE CUBE LARGE	\$37.40	717996449934	30717996449935	NA	NA	NA
56	BCSMD	SMOKE CUBE MEDIUM	\$37.40	717996449835	30717996449836	NA	NA	NA
56	BCSSM	SMOKE CUBE SMALL	\$37.40	717996449736	30717996449737	NA	NA	NA
13	BKOV	OVAL STAINLESS WIRE BASKET	\$21.70	717996237340	30717996237341	1.19	11.00	12
13	BKRD7	WIRE BASKET 7" ROUND	\$20.10	717996237654	30717996237655	2.22	27.00	48
13	BKRO	WIRE BASKET 9" ROUND S/S	\$21.70	717996237357	30717996237358	4.92	46.00	48
13	BKTA	TALL CHROMED WIRE BASKET	\$19.90	717996238637	30717996238638	5.06	16.80	6
13	BKWI	OVAL CHROMED WIRE BASKET	\$19.90	717996238644	30717996238645	1.90	11.10	6
26	BLCH	BASIC MODERN LID TRANSPARENT	\$15.50	4002458000362	04002458000362	0.26	2.00	12
26	BLFG	BASIC MODERN LID FOREST GREEN	\$15.50	717996224333	30717996224334	0.26	2.00	12
26	BLPB	BASIC MODERN LID LAVA RED	\$15.50	717996224340	30717996224341	0.26	2.00	12
26	BLPC	BASIC MODERN LID AZURE BLUE	\$15.50	717996224357	30717996224358	0.26	2.00	12
26	BLPP	BASIC MODERN LID ANTHRACITE	\$15.50	717996224388	30717996224389	0.26	2.00	12
24	BNP19	BREW N' POUR 1.9 LITER STAINLE	\$72.40	717996209019	30717996209010	1.80	16.60	6
24	BNP19OR	BREW N'POUR 1.9 LITER SS DECAF	\$72.40	717996208999	30717996208990	1.80	16.60	6
24	BNPL	BREW N' POUR REPLACEMENT LID	\$7.30	717996209026	30717996209027	0.26	2.00	12
24	BNPLOR	BREW N' POUR REPLACEMENT LID O	\$7.30	717996209033	30717996209034	0.26	2.00	12
56	BT3036C	30 36 CLEAR BOWL W/ LG CUBE	\$314.20	717996444342	30717996444343	NA	NA	1
56	BT3036S	30 36 SMOKE BOWL W/ LG CUBE	\$314.20	717996444335	30717996444336	NA	NA	1
16	BTLAL	BREW N' POUR LID ALMOND	\$7.30	717996340002	30717996340003	0.26	1.50	12
16	BTLBL	BREW N' POUR LID BLACK	\$7.30	717996340019	30717996340010	0.26	1.50	12
16	BTLBR	BREW N' POUR LID BROWN	\$7.30	717996340316	30717996340317	0.26	1.50	12
16	BTLBU	BREW N' POUR LID BURGUNDY	\$7.30	717996340026	30717996340027	0.26	1.50	12
16	BTLCBT	BREW N' POUR LID COBALT BLUE	\$7.30	717996340323	30717996340324	0.26	1.50	12
16	BTLCOB	BREW N' POUR LID CNTRY BLUE	\$7.30	717996340330	30717996340331	0.26	1.50	12
16	BTLFG	BREW N' POUR LID FOREST GREEN	\$7.30	717996340057	30717996340058	0.26	1.50	12
16	BTLGR	BREW N' POUR LID GRAY	\$7.30	717996340347	30717996340348	0.26	1.50	12
16	BTLMV	BREW N' POUR LID MAUVE	\$7.30	717996340354	30717996340355	0.26	1.50	12
16	BTLOR	BREW N' POUR LID ORANGE	\$7.30	717996340309	30717996340300	0.26	1.50	12
16	BTLWH	BREW N' POUR LID WHITE	\$7.30	717996340132	30717996340133	0.26	1.50	12
56	BVS8	VELCRO SET	\$2.50	717996449989	30717996449980	NA	NA	NA
48	CBR915	COFFEE BOX RACK 9 X 15	\$68.00	717996246090	30717996246091	NA	NA	NA
31	CGC060CP	CLASSIC CARAFE .6L COPPER/BRN	\$30.90	717996237081	30717996237082	1.12	11.80	6
31	CGC060SS	CLASSIC CARAFE .6L S/S/BLACK	\$30.90	717996237098	30717996237099	1.12	11.80	6
31	CGC101CP	CLASSIC CARAFE 1L COPPER/BRN	\$32.70	717996237371	30717996237372	1.29	13.20	6
31	CGC101SS	CLASSIC CARAFE 1L S/S/BLACK	\$32.70	717996237395	30717996237396	1.29	13.20	6
24	CGCS060CP	CARAFE .6L CPR/BRN W/S/S LINR	\$46.40	717996237630	30717996237631	1.12	12.60	6
24	CGCS060SS	CARAFE .6L S/S BODY&LINER	\$46.40	717996237647	30717996237648	1.12	12.60	6
24	CGCS10CP	CARAFE 1L CPR/BRN W/S/S LINR	\$48.30	717996237661	30717996237662	1.29	14.40	6
24	CGCS10SS	CARAFE 1L S/S/BLK W/S/S LINR	\$48.30	717996237623	30717996237624	1.29	14.40	6
31	CGRL1	GLASS LINER 1L FOR CGC1	\$12.10	717996237418	30717996237419	2.84	24.80	24
24	CGRL1SS	STAINLESS LINER 1L FOR CGC	\$24.60	717996237678	30717996237679	2.88	28.20	24
31	CGRL6	.6L REPLACEMENT GLASS LINER	\$12.10	717996237906	30717996237907	2.04	19.60	24
24	CGRL6SS	STAINLESS LINER .6L FOR CGC	\$21.80	717996237753	30717996237754	2.23	25.20	24
24	CGSTOP1	STOPPER LID BLACK F/CGC 1L,.6L	\$4.10	717996237425	30717996237426	0.26	0.80	12
24	CGSTOP2	STOPPER LID BROWN F/CGC 1L,.6L	\$4.10	717996237968	30717996237969	0.26	0.60	6
24	CGSTOPOR	STOPPER LID ORANGE FOR CGC101	\$4.10	717996237845	30717996237846	0.26	0.60	6
31	CJ10SS	CARAFE GLASS VACUUM 1L	\$43.20	717996237432	30717996237433	1.60	14.20	6
31	CJ10WHG	CLASSY 1.0 L WHITE W/GOLD LID	\$43.20	717996238460	30717996238461	1.56	15.00	6
31	CJ1BS	CARAFE 1L BRUSHED S/S & CHROME	\$43.20	717996238361	30717996238362	1.60	14.20	6
31	CJ1CH	CARAFE GLASS LINED 1L CHROME	\$43.20	717996237777	30717996237778	1.60	14.20	6
31	CJ6CH	CARAFE GLASS LINED .6L CHROME	\$36.40	717996237760	30717996237761	1.13	12.20	6
31	CJ6SS	CLASSIC CARAFE .6L	\$36.40	717996237449	30717996237440	1.13	12.20	6
31	CJL1WHG	WHITE/GOLD REPL LID F/CJ10WHG	\$7.30	717996238538	30717996238539	0.26	0.90	6
31	CJRL1	GLASS LINER FOR CJ 1LITER	\$15.90	717996237456	30717996237457	2.98	20.00	24
31	CJRL1BL	CJ 1LTR BLACK REPLACEMENT LID	\$7.30	717996237470	30717996237471	0.26	0.90	6
31	CJRL1BLD	CJ 1LTR BLACK REPLMT DECAF LID	\$7.30	717996237791	30717996237792	0.26	0.90	6
31	CJRL1CH	CJ CHROME REPLACEMENT LID	\$7.30	717996000135	30717996000136	0.26	0.90	6
31	CJRL1CHD	CJ CHROME REPLMT DECAF LID	\$7.30	717996238347	30717996238348	0.26	0.90	6
31	CJRL6	GLASS LINER .6L FOR CJ6	\$15.90	717996237463	30717996237464	NA	0.40	1
53	CLID	CEREAL DISPENSER LID S/S	\$57.20	717996274147	30717996274148	NA	NA	1
53	CLID7	CEREAL DISPENSER 7L LID S/S	\$62.90	717996274284	30717996274285	NA	NA	1
53	CLOCHEIS	REFRIG S/S TRAY W/COVER 22X14	\$601.70	717996271061	30717996271062	4.02	20.60	1
52	CONT1	7 LT ACRYLIC REPL CONTAINER	\$137.30	717996274055	30717996274056	1.03	3.20	1

PAGE	PRODUCT CODE	PRODUCT DESCRIPTION	2008 LIST EACH PRICE	PRODUCT UPC	CASE UPC	CUBE.	CASE. WT.	CASE QTY
52	CONT2	4 LT ACRYLIC REPL CONTAINER	\$118.70	717996274062	30717996274063	0.51	2.00	1
53	CYPACK	CEREAL DISP CONT,PADDLE,HDWARE	\$131.60	717996274154	30717996274155	NA	1.80	1
38	DSOR18	DECANTER SLEEVE ORANGE for 1.8	\$1.00	717996000524	30717996000525	NA	NA	NA
47	DT412AL	4X12 ALUM/PLS DRIP TRAY F/ROTO	\$39.00	717996246083	30717996246084	NA	0.40	1
47	DT412BL	4X12 BLK/PLS DRIP TRAY F/ROTO	\$39.00	717996246144	30717996246145	NA	0.40	1
47	DT412GD	4X12 GOLD/PLS DRIP TRAY F/ROTO	\$39.00	717996246151	30717996246152	NA	0.40	1
48	DT45	DRIP TRAY OCTAGON 4.5" BLACK	\$6.20	717996239009	30717996239000	1.40	16.60	120
30	DX10	LINER GLASS 1L FOR TPS	\$16.60	717996250080	30717996250081	2.06	14.60	12
30	DX16	LINER GLASS 1.6L FOR TPS	\$16.60	717996250097	30717996250098	2.52	18.60	24
30	DX19	LINER GLASS 1.9L FOR TPS	\$16.60	717996250103	30717996250104	NA	1.20	1
42	ECA19S	ECO-AIR PUMP 1.9L SATIN S/S	\$56.10	717996235865	30717996235866	2.92	25.40	6
42	ECA22PBL	ECO-AIR PUMP 2.2L PLASTIC BLK	\$64.20	717996236022	30717996236023	2.88	26.00	6
42	ECA22PBLMAT	ECO-AIR PUMP 2.2L PLASTIC BLK MAT	\$64.20	717996238330	30717996238331	2.88	26.00	6
42	ECA22PBU	ECO-AIR PUMP 2.2L BURGUNDY	\$64.20	717996236039	30717996236030	2.88	26.00	6
42	ECA22PFG	ECO-AIR PUMP 2.2L PLAS FOR.GRN	\$64.20	717996236046	30717996236047	2.88	26.00	6
42	ECA22PWH	ECO-AIR PUMP 2.2L PLAST WHITE	\$64.20	717996236015	30717996236016	2.88	26.00	6
42	ECA22S	ECO-AIR PUMP 2.2L SATIN S/S	\$55.50	717996236008	30717996236009	2.88	26.00	6
42	ECA22SBPBLMAT	2.2L SMOOTH PLS BLK MAT PUMP	\$64.20	717996236688	30717996236689	2.88	26.00	6
42	ECA25S	ECO-AIR PUMP 2.5L SATIN S/S	\$60.70	717996236107	30717996236108	3.04	28.60	6
42	ECA25SBPBLMAT	2.5L SMOOTH PLS BLK MAT PUMP	\$78.80	717996236695	30717996236696	3.04	28.60	6
43	ECAGASxx	ECO-AIR GASKETS: Lid, Suction Pipe, Liner	\$2.40	NA	NA	NA	NA	1
42	ECAL25BPBLMAT	2.5L SMOOTH PLS BLK MAT LEVER	\$78.80	717996236671	30717996236672	3.04	28.60	6
42	ECAJ22S	JEWEL 2.2 LITER PUMP AIRPOT	\$67.40	717996236589	30717996236580	2.88	26.40	6
42	ECAJL22S	JEWEL 2.2 LITER LEVER AIRPOT	\$67.40	717996236596	30717996236597	2.88	26.40	6
42	ECAL19S	ECO-AIR LEVER 1.9L SATIN S/S B	\$56.10	717996237043	30717996237044	2.92	26.00	6
42	ECAL22PBL	ECO-AIR LEVER 2.2L PLASTIC BLK	\$64.20	717996236138	30717996236139	2.88	26.40	6
42	ECAL22PBLMAT	ECO-AIR LEVER 2.2L PLASMAT BLK	\$64.20	717996236541	30717996236542	2.88	26.40	6
42	ECAL22PBU	ECO-AIR LEVER 2.2L BURGUNDY	\$64.20	717996236145	30717996236146	2.88	26.40	6
42	ECAL22PFG	ECO-AIR LEVER 2.2L PLAS FOR.GRN	\$64.20	717996236152	30717996236153	2.88	26.40	6
42	ECAL22PWH	ECO-AIR PUMP 2.2L PLAST WHITE	\$64.20	717996236121	30717996236122	2.88	26.40	6
42	ECAL22S	ECO-AIR LEVER 2.2L SATIN S/S	\$55.50	717996237050	30717996237051	2.88	26.40	6
42	ECAL22SBPBLMAT	2.2L SMOOTH PLS BLK MAT LEVER	\$64.20	717996236664	30717996236665	2.88	26.40	6
42	ECAL25S	ECO-AIR LEVER 2.5L SATIN S/S B	\$60.70	717996237036	30717996237037	3.04	28.80	6
42	ECALS22PBL	ECO-AIR LEVER 2.4L PLASBLK S/S LD	\$86.70	717996236398	30717996236399	2.88	26.40	6
42	ECALS22PBLMAT	ECO-AIR LEVER 2.4L PLASMAT BLK S/S LD	\$86.70	717996236794	30717996236795	2.88	26.40	6
42	ECALS22PBU	ECO-AIR LEVER 2.4L PLASBU S/S LD	\$86.70	717996236404	30717996236405	2.88	26.40	6
42	ECALS22PFG	ECO-AIR LEVER 2.4L PLASFG S/S LD	\$86.70	717996236411	30717996236412	2.88	26.40	6
42	ECALS22PWH	ECO-AIR LEVER 2.4L PLASWH S/S LD	\$86.70	717996236763	30717996236764	2.88	26.40	6
42	ECALS22SBPBLMAT	2.4L SMOOTH PLS BLK MAT LV S/S	\$86.70	717996238750	30717996238751	2.88	26.40	6
42	ECALS22SS	ECO-AIR LEVER 2.4L S/S LINER	\$79.60	717996236305	30717996236306	2.88	26.40	6
42	ECAS22PBL	ECO-AIR PUMP 2.4L PLASBLK S/S LD	\$86.70	717996236343	30717996236344	2.88	26.00	6
42	ECAS22PBLMAT	ECO-AIR PUMP 2.4L PLASMAT BLK S/S LD	\$86.70	717996236817	30717996236818	2.88	26.00	6
42	ECAS22PBU	ECO-AIR PUMP 2.4L PLASBU S/S LD	\$86.70	717996236350	30717996236351	2.88	26.00	6
42	ECAS22PFG	ECO-AIR PUMP 2.4L PLSFGRN S/S LD	\$86.70	717996236367	30717996236368	2.88	26.00	6
42	ECAS22PWH	ECO-AIR PUMP 2.4L PLASWH S/S LD	\$86.70	717996236602	30717996236603	2.88	26.00	6
42	ECAS22S	ECO-AIR PUMP 2.4L S/S LINER	\$79.60	717996236329	30717996236320	2.88	26.00	6
42	ECAS22SBPBLMAT	ECO-AIR PUMP 2.4L SMOOTH BLK MAT P/S SS LD	\$86.70	717996238804	30717996238805	2.88	26.00	6
19	ECLBL	ECO-SERV LID 44 OZ. BLACK	\$4.50	717996310012	30717996310013	0.21	3.00	12
19	ECLWH	ECO-SERV LID 44 OZ. WHITE	\$4.50	717996310135	30717996310136	0.21	3.00	12
19	ECO13BL	ECO-SERV 44 OZ. BLACK	\$19.50	717996170012	30717996170013	2.48	17.00	12
19	ECO13WH	ECO-SERV 44 OZ. WHITE	\$19.50	717996170135	30717996170136	2.48	17.00	12
19	ECO6BL	ECO-SERV .6L BLACK	\$17.30	717996162024	30717996162025	1.55	12.00	12
19	ECO6WH	ECO-SERV .6L WHITE	\$17.30	717996162031	30717996162032	1.55	12.00	12
43	ELLBL	ECO-AIR LEVER LID	\$16.80	717996237067	30717996237068	2.60	21.30	30
43	ELLBLORT	ECO-AIR LEVER LID 1.9-2.5LTR D	\$16.80	717996991242	30717996991243	3.26	20.00	30
43	ELLOR	ECO-AIR LEVER LID ALL ORANGE	\$16.80	717996237074	30717996237075	3.26	20.00	30
43	EPL22BL	ECO-AIR PUMP LID 2.2L	\$16.80	717996991259	30717996991250	3.26	20.00	30
43	EPL22OR	ECO-AIR PUMP LID 2.2L ALL ORAN	\$16.80	717996237111	30717996237112	3.26	20.00	30
43	EPLOR	ECO-AIR PUMP LID DECAF	\$16.80	717996991266	30717996991267	3.26	20.00	30
43	ERL19	ECO-AIR GLASS LINER 1.9L	\$26.90	717996237821	30717996237822	NA	1.58	1
43	ERL22	ECO-AIR GLASS LINER 2.2L	\$26.90	717996237005	30717996237006	NA	2.00	1
43	ERL22SS	ECO-AIR S/S LINER 2.4L	\$35.00	717996236336	30717996236337	NA	2.20	1
43	ERL25	ECO-AIR GLASS LINER 2.5L	\$26.90	717996237104	30717996237105	NA	2.10	1
43	ESP19	ECO-AIR SUCTION PIPE FOR 1.9L	\$10.40	717996236992	30717996236993	NA	0.10	1
43	ESP22	ECO-AIR SUCTION PIPE FOR 2.2L	\$10.40	717996237012	30717996237013	NA	0.10	1
43	ESP22SS	ECO-AIR SUCT PIPE FOR 2.4L SS	\$10.40	717996238415	30717996238416	NA	0.10	1
43	ESP25	ECO-AIR SUCTION PIPE FOR 2.5L	\$10.40	717996236985	30717996236986	NA	0.10	1
22	FBCOLD	FLAVOR BAND COLD PACE	\$2.10	717996245178	30717996245179	0.01	1.00	6
22	FBCREAM	FLAVOR BAND CREAM-WHITE W/BLK	\$2.10	717996245048	30717996245049	0.01	1.00	6
22	FBDECAF	FLAVOR BAND DECAF-ORANG W/BLK	\$2.10	717996245055	30717996245056	0.01	1.00	6
22	FBHALF&HALF	FLAVOR BAND HALF & HALF-WHITE	\$2.10	717996245062	30717996245063	0.01	1.00	6

PAGE	PRODUCT CODE	PRODUCT DESCRIPTION	2008 LIST EACH PRICE	PRODUCT UPC	CASE UPC	CUBE	CASE WT.	CASE QTY
22	FBHOTWATER	FLAVOR BAND HOT WATER-RED W/BL	\$2.10	717996245079	30717996245070	0.01	1.00	6
26	FBLE	FROSTED BALL TWIST LID BLACK	\$11.70	717996224449	30717996224440	0.26	1.00	12
26	FBLKC	FROSTED BALL TWST LID COBLTBLU	\$11.70	717996224456	30717996224457	0.26	1.00	12
26	FBLPA	FROSTED BALL TWIST LID WHITE	\$11.70	717996224463	30717996224464	0.26	1.00	12
26	FBLPP	FROSTED BALL TWSTLID ANTHR GRY	\$11.70	717996224500	30717996224501	0.26	1.00	12
26	FBLSV	FROSTED BALL TWIST LID SILVER	\$11.70	717996224708	30717996224709	0.26	1.00	12
22	FBREGULAR	FLAVOR BAND REGULAR-BLK W/WHT	\$2.10	717996245086	30717996245087	0.01	1.00	6
22	FBSKIM	FLAVOR BAND SKIM-WHITE W/BLACK	\$2.10	717996245093	30717996245094	0.01	1.00	6
26	FBSLO10	SHINY BALL (0175) LID TRANSPAR	\$11.70	4002458444845	04002458444845	0.26	1.00	12
26	FBSLO33	SHINY BALL (0175) LID LAVA RED	\$11.70	4002458444852	04002458444852	0.26	1.00	12
26	FBSLO52	SHINY BALL (0175) LID COB BLUE	\$11.70	4002458444869	04002458444869	0.26	1.00	12
26	FBSL970	SHINY BALL (0175) LID COGNAC	\$11.70	4002458444883	04002458444883	0.26	1.00	12
26	FBSL971	SHINY BALL (0175) LID ORANGE	\$11.70	4002458444890	04002458444890	0.26	1.00	12
22	FBTEA	FLAVOR BAND TEA-GREEN W/BLACK	\$2.10	717996245109	30717996245100	0.01	1.00	6
26	FBTLB	FROSTED BALL TRIG LID RED	\$11.70	4002458423918	04002458423918	0.26	1.00	12
26	FBTLC	FROSTED BALL TRIG LID NITE BLU	\$11.70	717996224722	30717996224723	0.26	1.00	12
26	FBTLCD	FROSTED BALL TRIG LID CARLEMON	\$11.70	717996224739	30717996224730	0.26	1.00	12
26	FBTLE	FROSTED BALL TRIG LID BLACK	\$11.70	717996224746	30717996224747	0.26	1.00	12
26	FBTLKC	FROSTED BALL TRIG LID COBALT B	\$11.70	717996224753	30717996224754	0.26	1.00	12
26	FBTLPA	FROSTED BALL TRIG LID WHITE	\$11.70	4002458079832	04002458079832	0.26	1.00	12
26	FBTLPP	FROSTED BALL TRIG LID ANTR.GRY	\$11.70	717996224784	30717996224785	0.26	1.00	12
26	FBTLV	FROSTED BALL TRIG LID SILVER	\$11.70	717996224821	30717996224822	0.26	1.00	12
22	FBVARIETY	FLAVOR BAND VARIETY - 7PK	\$14.70	717996245116	30717996245117	0.01	1.00	6
10-11	FP1/RO117AL	THERMO PLT FISH INSERT ALUMINU	\$29.50	717996471515	30717996471516	0.11	5.20	12
10-11	FP1/RO117SS	THERMO PLT FISH INSERT SS	\$35.00	717996471317	30717996471318	0.11	11.20	12
11	FP1BL	THERMO PLT FISH HOLDER BLACK	\$12.30	717996471010	30717996471011	0.80	8.20	12
11	FP1BLAC	THERMO FISH PLTR ALUM COMP BLK	\$41.80	717996470105	30717996470106	0.80	30.00	12
11	FP1BLC	THERMO PLT FISH PLTR COMP BLK	\$47.30	717996470013	30717996470014	0.80	11.60	12
11	FP3BL	THERMO PLT SPR FISH HLDR BLK	\$25.70	717996472017	30717996472018	2.28	56.00	6
11	FP3BLC	THERMO PLT SPR FISH COMP BLACK	\$67.10	717996473014	30717996473015	0.49	36.00	6
11	FP3SS	THERMO PLT SUPER FISH SS INSR	\$41.40	717996472314	30717996472315	1.17	17.00	6
38	FROTH206	FROTHING PITCHR 20 OZ/6 OZ INC	\$10.70	717996238378	30717996238379	2.42	15.60	24
38	FROTH326	FROTHING PITCHR 32 OZ/6 OZ INC	\$12.20	717996238422	30717996238423	2.42	19.00	24
38	FROTH506	FROTHING PITCHR 50 OZ/6 OZ INC	\$17.90	717996238439	30717996238430	2.17	12.80	12
38	FROTH646	FROTHING PITCHR 64 OZ/6 OZ INC	\$22.47	717996238446	30717996238447	2.17	15.60	12
43	FSDRT	FLAVOR STICKERS DECAF, REG, TEA	\$5.50	717996179367	30717996179368	NA	NA	NA
19	FT1OR	ECO-SERV DECAF INDICATOR ORANG	\$1.00	717996179305	30717996179306	NA	0.01	1
22	FVP12	STEELVAC SERVER 1.2L SS	\$50.10	717996217328	30717996217329	1.32	13.40	6
22	FVP12D	STEELVAC SERVER 1.2L SS DECAF	\$50.10	717996217328	30717996217329	1.32	13.40	6
22	FVP15	STEELVAC SERVER 1.5L SS	\$55.60	717996215324	30717996215325	1.54	14.20	6
22	FVP15D	STEELVAC SERVER 1.5L SS DECAF	\$55.60	717996215324	30717996215325	1.54	14.20	6
22	FVP20	STEELVAC SERVER 2.0L SS	\$61.20	717996210329	30717996210320	1.64	15.60	6
22	FVP20D	STEELVAC SERVER 2.0L SS DECAF	\$61.20	717996210329	30717996210320	1.64	15.60	6
22	FVPBTL	FVP BREW-TRU LID	\$7.30	717996410149	30717996410140	0.26	1.92	12
22	FVPBTLOR	FVP BREW-TRU LID ORANGE	\$7.30	717996217458	30717996217459	0.26	1.90	12
22	FVPL	FVP LID BLACK TRIGGER	\$7.30	717996410125	30717996410126	0.26	1.90	12
22	FVPLOR	FVP LID ORANGE TRIGGER	\$7.30	717996410132	30717996410133	0.26	1.90	12
55	GIU15G	GRAVITY DISPENSER 1.5 GAL S/S	\$385.20	717996230464	30717996230465	2.95	17.00	1
55	GIU15GFUN	GIU15G FUNNEL ASSEMBLY	\$26.20	717996230556	30717996230557	NA	0.40	1
55	GIU15GKIT	GIU15G SIGHT GLASS KIT	\$15.10	717996230488	30717996230489	NA	0.10	1
55	GIU15GSHIELD	GIU15G GAUGE GLASS SHIELD	\$9.30	717996230563	30717996230564	NA	0.20	1
55	GIU2G	GRAVITY DISPENSER 2 GAL S/S	\$407.90	717996230358	30717996230359	3.23	17.40	1
55	GIU2GDT	GIU2G & 15G DRIP TRAY & GRATE	\$9.30	717996230402	30717996230403	NA	0.10	1
55	GIU2GFAUC	GIU2G/GIU15 HORIZONTAL FAUCET	\$30.20	717996230396	30717996230397	NA	0.10	1
55	GIU2GFUN	GIU2G FUNNEL ASSEMBLY	\$30.20	717996230365	30717996230366	NA	0.40	1
55	GIU2GKIT	GIU2G SIGHT GLASS KIT	\$23.70	717996230419	30717996230410	NA	0.10	1
55	GIU2GLIDH	GIU2G/GIU15G LID WITH HANDLES	\$30.20	717996230471	30717996230472	NA	1.00	1
55	GIU2GSHIELD	GIU2G GAUGE GLASS SHIELD	\$9.30	717996230372	30717996230373	NA	0.20	1
55	GIUMOUNT	GIU LINR MOUNTG & PLUG F/1.5&2	\$9.30	717996230570	30717996230571	NA	0.20	1
55	GIUPLUG	GIU BOTTOM PLUG F/1.5&2L GRAV	\$2.40	717996230594	30717996230595	NA	NA	1
55	GIUPLSTAND	PLASTIC STAND FOR GIU15 & GIU2G	\$155.70					
55	GIUSTAND	GIU STAND FOR 1.5 & 2 L GRAVIT	\$59.40	717996230587	30717996230588	NA	NA	NA
52	GSP1P7W	ZEPE JUICE DISP 7L WHITE POLY	\$459.00	717996271009	30717996271000	2.86	9.40	1
52	GSP1S4	ZEPE JUICE DIS 4L STAINLESS	\$524.70	717996991563	30717996991564	1.49	7.80	1
52	GSP1S7	ZEPE JUICE DISP 7 LITER S/S	\$690.30	717996991556	30717996991557	2.86	12.40	1
52	GSPSDT	GRATE 4.25" 1S4,1S7,1P7W,LATTE	\$17.20	717996270323	30717996270324	NA	0.05	1
52	GSPSDT2	GRATE 4" GSP2MIGNON,807 SER	\$17.20	717996270569	30717996270560	NA	0.05	1
52	GSPSDT3	GRATE 4.75" F/GSP1L&GSP2NINO	\$17.20	717996270576	30717996270577	NA	0.05	1
27	HANDY.6BL	HANDY SERVER .6 LITER BLACK	\$48.80	4002458072406	04002458072406	0.48	2.80	2
27	HANDY.6WH	HANDY SERVER .6 LITER WHITE	\$48.80	4002458072390	04002458072390	0.48	2.80	2
27	HANDY1BL	HANDY SERVER 1 LITER BLACK	\$58.00	4002458072444	04002458072444	0.25	3.00	1

PAGE	PRODUCT CODE	PRODUCT DESCRIPTION	2008 LIST EACH PRICE	PRODUCT UPC	CASE UPC	CUBE.	CASE WT.	CASE QTY
27	HANDY1WH	HANDY SERVER 1 LITER WHITE	\$58.00	4002458072437	04002458072437	0.25	3.00	1
48	HAP9SH	PLASTSIGNHLDR GOLD/MOUNT STEM	\$22.80	717996245802	30717996245803	NA	0.20	1
49	HCT2	CONDIMENT TRAY 2 PART	\$88.00	717996245505	30717996245506	0.48	3.00	1
49	HCT4	CONDIMENT TRAY 4 PART	\$151.00	717996245512	30717996245513	0.86	5.20	1
48	HR21B	AIRPOT STD SGLE/DRIP TRY(API0)	\$203.00	717996245543	30717996245544	0.35	3.20	1
12	HS13BL	INSULATED SKILLET HOLDER BLACK	\$33.20	717996479016	30717996479017	0.95	13.05	6
39	IB13SS	ICE BUCKET 1.3L STAINLESS	\$82.00	717996430154	30717996430155	3.56	43.00	12
39	IB3BL	ICE BUCKET 3L W/LID BLACK	\$32.90	717996430017	30717996430018	1.94	9.40	6
39	IBL3BL	ICE BUCKET LID BLACK	\$4.10					
39	IBSSPARTS	INSIDE DISK FOR IB13SS ICEBUCK	\$5.50	717996130160	30717996430161	NA	NA	1
39	IBT12CH	ICE BUCKET W/TONGS POLISH S/S	\$31.80	717996430177	30717996430178	2.45	28.20	12
52	ICE1	ICE HOLDER 7 LITER ACRYLIC	\$58.80	717996274000	30717996274001	NA	0.80	1
52	ICE2	ZEPE ICE HOLDER 3 LITER	\$52.20	717996274017	30717996274018	NA	0.50	1
48	IDCHCF	I D CHAIN COFFEE / CHROME	\$13.90	717996990412	30717996990413	0.26	0.30	6
48	IDCHDE	I D CHAIN DECAF / CHROME	\$13.90	717996990429	30717996990420	0.26	0.30	6
48	IDCHHW	I D CHAIN HOT WATER / CHROME	\$13.90	717996990436	30717996990437	0.26	0.30	6
48	IDVAR	I D CHAIN VARIETY PACK	\$41.70	717996990498	30717996990499	0.26	2.00	1
57	IT3GPL	3G S/S ICE TEA DISP SS&PLS LID	\$110.80	717996230426	30717996230427	2.01	9.00	1
57	IT5GPL	5G S/S ICE TEA DISP SS&PLS LID	\$124.30	717996230433	30717996230434	2.72	11.00	1
57	ITPRL	PLASTIC LID FOR ICE TEA DISPSR	\$30.00	717996230440	30717996230441	NA	0.70	1
57	ITSPIG	ICE TEA URN SPIGOT ONLY	\$28.60	717996230495	30717996230496	NA	NA	NA
57	ITSRL	STAINLESS REPL LID F/IT3,IT5	\$30.00	717996230457	30717996230458	NA	0.20	1
52	JLID807	807 series 4LITER STAINLESS JUICE REPL LID	\$56.70	717996271108	30717996271109	NA	NA	1
52	JLID8077	807 series 7LITER STAINLESS JUICE REPL LID	\$58.00	717996271146	30717996271147	NA	NA	1
52	JLIDP1	WHITE REPLACEMENT LID 7L	\$56.70	717996271115	30717996271116	NA	NA	1
52	JLIDS1	STAINLESS REPLACEMENT LID 7L	\$98.80	717996271078	30717996271079	NA	0.80	1
52	JLIDS2	STAINLESS REPLACEMENT LID 4L	\$85.90	717996271085	30717996271086	NA	0.50	1
43	KITECASS25	CONVERSION KIT FOR ECA GL TO S/S	\$42.80	717996236626	30717996236627	NA	3.50	1
34	LO01Z	LOTUS BLK TEAPOT .75L W/INFUSE	\$47.30	8711871026656	08711871026656	1.40	18.00	8
34	LO02Z	LOTUS BLK TEAPOT 1.2L W/INFUSE	\$52.50	8711871026700	08711871026700	2.12	28.25	8
33	L12	COFFEE PRESS REPLMT LNR 1500CC	\$23.10	717996224524	30717996224525	1.90	12.00	12
33	L3	COFFEE PRESS REPLMT LNR 350CC	\$11.20	717996224531	30717996224532	1.40	6.00	24
33	L4	COFFEE PRESS REPLMT LNR 600CC	\$13.20	717996224661	30717996224662	2.30	12.00	24
33	L6	COFFEE PRESS REPLMT LNR 800CC	\$15.50	717996224548	30717996224549	2.34	13.50	24
33	L8	COFFEE PRESS REPLMNT LNR 1000C	\$17.80	717996224555	30717996224556	2.25	16.00	24
52	LATTE6S	ZEPE MILK DISP 6 LTR STAINLESS	\$961.90	717996271054	30717996271055	2.86	21.00	1
53	LID807	ZEPE 807 S/S CEREAL LID ONLY	\$52.50	717996271122	30717996271123	NA	NA	1
10	LO125SS	THERMO PLT INSERT 6" (HALF)	\$15.70	717996492312	30717996492313	0.09	7.80	12
10	LO12BL	THERMO PLT HLDR 12" BLACK	\$18.00	717996491018	30717996491019	0.60	14.80	12
10	LO12BLC	THERMO PLT HLDR BLACK W/STEEL	\$52.60	717996490011	30717996490012	0.60	30.60	12
10	LO12SS	THERMO PLT INSERT 12" S/S	\$34.60	717996491315	30717996491316	0.09	15.20	12
34	LTPB	INFUSER BASKET FOR LO0xZ	\$9.20	717996239634	717996239634	NA	0.01	1
34	LTPBL	LID FOR LO0xZ	\$12.00	717996239627	30717996239628	NA	NA	1
17	ML101CH/BL	METALLIC LUSTER 1L CHROME/BLK	\$38.80	717996070527	30717996070528	1.02	7.40	6
17	ML101MCPBL	MET LUSTER 1L COPPER/BLK	\$41.80	717996074600	30717996074601	1.26	9.80	6
17	ML101MSSBL	MET LUSTER 1L STAINLESS/BLACK	\$41.80	717996074631	30717996074632	1.26	9.80	6
17	ML315CH/BL	METALLIC LUSTER 1.5L CHROME/BL	\$48.40	717996050529	30717996050520	1.31	8.80	6
17	ML501CH/BL	METALLIC LUSTER .6L CHROME/BLK	\$35.70	717996060528	30717996060529	0.72	6.40	6
17	ML501MCPBL	MET LUSTR 20 OZ COPPR/BLK	\$39.70	717996074648	30717996074649	0.72	6.40	6
17	ML501MSSBL	MET LUSTR 20 OZ STAINLESS/BLK	\$39.70	717996074655	30717996074656	0.72	6.40	6
30	MT1	ID MAGNET 'BLANK' (1.25 x 3.5)	\$2.67	717996241002	30717996241003	0.03	0.06	6
30	MT12	ID MAGNET 2% (1.25 x 3.5)	\$2.67	717996241019	30717996241010	0.03	0.06	6
30	MT1AL	ID MAGNET ALMOND (1.25 x 3.5)	\$2.67	717996241026	30717996241027	0.03	0.06	6
30	MTIAM	ID MAGNET Amaretto(1.25 x 3.5)	\$2.67	717996241033	30717996241034	0.03	0.06	6
30	MT1BB	ID MAGNET BREAKFAST BLEND	\$2.67	717996241040	30717996241041	0.03	0.06	6
30	MT1CF	ID MAGNET COFFEE (1.25 x 3.5)	\$2.67	717996241057	30717996241058	0.03	0.06	6
30	MT1CO	ID MAGNET COLOMBIAN 1.25 x 3.5	\$2.67	717996241064	30717996241065	0.03	0.06	6
30	MT1CR	ID MAGNET CREAM (1.25 X 3.5)	\$2.67	717996241095	30717996241096	0.03	0.06	6
30	MT1DE	ID MAGNET DECAF (1.25 X 3.5)	\$2.67	717996241101	30717996241102	0.03	0.06	6
30	MT1FR	ID MAGNET FRENCH ROAST	\$2.67	717996241118	30717996241119	0.03	0.06	6
30	MT1FV	ID MAGNET FRENCH VANILLA	\$2.67	717996241125	30717996241126	0.03	0.06	6
30	MT1GB	ID MAGNET GOURMET BLEND	\$2.67	717996241132	30717996241133	0.03	0.06	6
30	MT1HA	ID MAGNET HAZELNUT (1.25x3.5)	\$2.67	717996241149	30717996241140	0.03	0.06	6
30	MT1HB	ID MAGNET HOUSE BLEND	\$2.67	717996241163	30717996241164	0.03	0.06	6
30	MT1HH	ID MAGNET HALF & HALF	\$2.67	717996241170	30717996241171	0.03	0.06	6
30	MT1HW	ID MAGNET HOT WATER	\$2.67	717996241187	30717996241188	0.03	0.06	6
30	MT1IC	ID MAGNET IRISH CREAM	\$2.67	717996241194	30717996241195	0.03	0.06	6
30	MT1ITE	ID MAGNET ICE TEA (1.25 x 3.5)	\$2.67	717996241286	30717996241287	0.03	0.06	6
30	MT1MI	ID MAGNET MILK (1.25 x 3.5)	\$2.67	717996241200	30717996241201	0.03	0.06	6
30	MT1MO	ID MAGNET MOCHA (1.25 x 3.5)	\$2.67	717996241217	30717996241218	0.03	0.06	6
30	MT1RE	ID MAGNET REGULAR (1.25 x 3.5)	\$2.67	717996241231	30717996241232	0.03	0.06	6

PAGE	PRODUCT CODE	PRODUCT DESCRIPTION	2008 LIST EACH PRICE	PRODUCT UPC	CASE UPC	CUBE	CASE WT.	CASE QTY
30	MTISM	ID MAGNET SKIM (1.25 x 3.5)	\$2.67	717996241262	30717996241263	0.03	0.06	6
30	MTITE	ID MAGNET TEA 1.25 x 3.5	\$2.67	717996241293	30717996241294	0.03	0.06	6
30	MTIVPA	ID MAGNET VARIETY PK 1.25x3.5	\$55.80	717996241927	30717996241928	0.26	0.23	23
30	MTCBICO	ID MAG COFBEAN COLOMBIAN (1.25 X 3.5)	\$2.95	717996245185	30717996245186	NA	NA	6
30	MTCBIDE	ID MAG COFBEAN DECAF (1.25 X 3.5)	\$2.95	717996245192	30717996245193	NA	NA	6
30	MTCBIFR	ID MAG COFBEAN FRROAST (1.25 X 3.5)	\$2.95	717996245208	30717996245209	NA	NA	6
30	MTCBIHB	ID MAG COFBEAN HOUSEBLEND (1.25 X 3.5)	\$2.95	717996245215	30717996245216	NA	NA	6
30	MTCB4CO	ID MAG COFBEAN COLOMBIAN (4 X 6)	\$3.95	717996245222	30717996245223	NA	NA	6
30	MTCB4DE	ID MAG COFBEAN DECAF (4 X 6)	\$3.95	717996245239	30717996245230	NA	NA	6
30	MTCB4FR	ID MAG COFBEAN FRROAST (4 X 6)	\$3.95	717996245246	30717996245247	NA	NA	6
30	MTCB4HB	ID MAG COFBEAN HOUSEBLEND (4 X 6)	\$3.95	717996245253	30717996245254	NA	NA	6
53	MULINO1PW	SINGLE CEREAL DISP 3L WHT POLY	\$433.50	717996271016	30717996271017	1.60	8.60	1
53	MULINO1S	SINGLE CEREAL DISP 3L STAINLES	\$489.60	717996274116	30717996274117	1.60	7.20	1
53	MULINO1S7	SINGLE 7 LTR CEREAL DISP S/S	\$588.50	717996271030	30717996271031	2.73	12.80	1
53	MULINO2PW	DOUBLE WHITE PLASTIC 3L	\$815.10	717996271023	30717996271024	2.73	14.0	1
53	MULINO2S	DBL CEREAL DISP 3L EACH STAINL	\$963.90	717996274130	30717996274131	2.86	13.00	1
16	NG101AL	NEW GEN SERVER 1L ALMOND	\$33.30	717996020003	30717996020004	1.06	7.00	6
16	NG101BL	NEW GEN SERVER 1L BLACK	\$33.30	717996020010	30717996020011	1.06	7.00	6
16	NG101BU	NEW GEN SERVER 1L BURGUNDY	\$33.30	717996020027	30717996020028	1.06	7.00	6
16	NG101CBT	NEW GEN SERVER 1L COBALT BLUE	\$33.30	717996020034	30717996020035	1.06	7.00	6
16	NG101FG	NEW GEN SERVER 1L FORST GREEN	\$33.30	717996020058	30717996020059	1.06	7.00	6
16	NG101GR	NEW GEN SERVER 1L GREY	\$33.30	717996020065	30717996020066	1.06	7.00	6
16	NG101MV	NEW GEN SERVER 1L MAUVE	\$33.30	717996020072	30717996020073	1.06	7.00	6
16	NG101ST/COB	NEW GEN SERVER 1L STON/CNTRY	\$33.30	717996020119	30717996020110	1.06	7.00	6
16	NG101WH	NEW GEN SERVER 1L WHITE	\$33.30	717996020133	30717996020134	1.06	7.00	6
16	NG421AL	NEW GEN SERVER 2L ALMOND	\$43.20	717996030002	30717996030003	1.64	10.00	6
16	NG421BL	NEW GEN SERVER 2L BLACK	\$43.20	717996030019	30717996030010	1.64	10.00	6
16	NG421BU	NEW GEN SERVER 2L BURGUNDY	\$43.20	717996030026	30717996030027	1.64	10.00	6
16	NG421CBT	NEW GEN SERVER 2L COBALT BLUE	\$43.20	717996030033	30717996030034	1.64	10.00	6
16	NG421FG	NEW GEN SERVER 2L FOREST GRN	\$43.20	717996030057	30717996030058	1.64	10.00	6
16	NG421GR	NEW GEN SERVER 2L GREY	\$43.20	717996030064	30717996030065	1.64	10.00	6
16	NG421MV	NEW GEN SERVER 2L MAUVE	\$43.20	717996030071	30717996030072	1.64	10.00	6
16	NG421ST/COB	NEW GEN SERVER 2L STON/CNTRY	\$43.20	717996030118	30717996030119	1.64	10.00	6
16	NG421WH	NEW GEN SERVER 2L WHITE	\$43.20	717996030132	30717996030133	1.64	10.00	6
16	NG501AL	NEW GEN SERVER .6L ALMOND	\$31.00	717996040001	30717996040002	0.75	5.60	6
16	NG501BL	NEW GEN SERVER .6L BLACK	\$31.00	717996040018	30717996040019	0.75	5.60	6
16	NG501BU	NEW GEN SERVER .6L BURGUNDY	\$31.00	717996040025	30717996040026	0.75	5.60	6
16	NG501CBT	NEW GEN SERVER .6L COBALT BLUE	\$31.00	717996040032	30717996040033	0.75	5.60	6
16	NG501FG	NEW GEN SERVER .6L FOREST GRN	\$31.00	717996040056	30717996040057	0.75	5.60	6
16	NG501GR	NEW GEN SERVER .6L GREY	\$31.00	717996040063	30717996040064	0.75	5.60	6
16	NG501MV	NEW GEN SERVER .6L MAUVE	\$31.00	717996040070	30717996040071	0.75	5.60	6
16	NG501ST/COB	NEW GEN SERVER .6L STON/CNTRY	\$31.00	717996040117	30717996040118	0.75	5.60	6
16	NG501WH	NEW GEN SERVER .6L WHITE	\$31.00	717996040131	30717996040132	0.75	5.60	6
16	NGLAL	NEW GEN LID ALMOND	\$7.30	717996320004	30717996320005	0.26	1.60	12
16	NGLALD	NEW GEN LID ALMOND W/DECAF	\$7.30	717996322008	30717996322009	0.26	1.60	12
16	NGLBL	NEW GEN LID BLACK	\$7.30	717996320011	30717996320012	0.26	1.60	12
16	NGLBLD	NEW GEN LID BLACK DECAF	\$7.30	717996322015	30717996322016	0.26	1.60	12
16	NGLBR	NEW GEN LID BROWN	\$7.30	717996320367	30717996320368	0.26	1.60	12
16	NGLBRD	NEW GEN LID BROWN DECAF	\$7.30	717996322367	30717996322368	0.26	1.60	12
16	NGLBU	NEW GEN LID BURGUNDY	\$7.30	717996320028	30717996320029	0.26	1.60	12
16	NGLBUD	NEW GEN LID BURGUNDY DECAF	\$7.30	717996322022	30717996322023	0.26	1.60	12
16	NGLCBT	NEW GEN LID COBALT BLUE	\$7.30	717996320035	30717996320036	0.26	1.60	12
16	NGLCBTD	NEW GEN LID COBALT BLUE DECAF	\$7.30	717996322039	30717996322030	0.26	1.60	12
16	NGLCOB	NEW GEN LID COUNTRY BLUE	\$7.30	717996320042	30717996320043	0.26	1.60	12
16	NGLCOBD	NEW GEN LID COUNTRY BLUE DECAF	\$7.30	717996322046	30717996322047	0.26	1.60	12
16	NGLFG	NEW GEN LID FOREST GREEN	\$7.30	717996320059	30717996320050	0.26	1.60	12
16	NGLFGD	NEW GEN LID FORST GREEN DECAF	\$7.30	717996322053	30717996322054	0.26	1.60	12
16	NGLGAS	GASKET FOR NEW GENERATION LID	\$2.10	717996329007	30717996329008	0.26	1.60	12
16	NGLGR	NEW GEN LID GRAY	\$7.30	717996320066	30717996320067	0.26	1.60	12
16	NGLGRD	NEW GEN LID GRAY DECAF	\$7.30	717996322060	30717996322061	0.26	1.60	12
16	NGLMV	NEW GEN LID MAUVE	\$7.30	717996320073	30717996320074	0.26	1.60	12
16	NGLMVD	NEW GEN LID MAUVE DECAF	\$7.30	717996322077	30717996322078	0.26	1.60	12
16	NGLOR	NEW GEN LID ORANGE	\$7.30	717996320301	30717996320302	0.26	1.60	12
16	NGLWAL	NEW GEN WELDED LID ALMOND	\$7.30	717996330003	30717996330004	0.26	1.60	12
16	NGLWALD	NEW GEN W-LID ALMOND DECAF	\$7.30	717996332008	30717996332009	0.26	1.60	12
16	NGLWBL	NEW GEN WELDED LID BLACK	\$7.30	717996330010	30717996330011	0.26	1.60	12
16	NGLWBLD	NEW GEN W-LID BLACK DECAF	\$7.30	717996332014	30717996332015	0.26	1.60	12
16	NGLWBR	NEW GEN WELDED LID BROWN	\$7.30	717996330362	30717996330363	0.26	1.60	12
16	NGLWBRD	NEW GEN W-LID BROWN DECAF	\$7.30	717996332366	30717996332367	0.26	1.60	12
16	NGLWBU	NEW GEN WELDED LID BURGUNDY	\$7.30	717996330025	30717996330026	0.26	1.60	12
16	NGLWBUD	NEW GEN W-LID BURGUNDY DECAF	\$7.30	717996332021	30717996332022	0.26	1.60	12

PAGE	PRODUCT CODE	PRODUCT DESCRIPTION	2008 LIST EACH PRICE	PRODUCT UPC	CASE UPC	CUBE.	CASE WT.	CASE QTY
16	NGLWCBT	NEW GEN WELDED LID COBALT BLUE	\$7.30	717996330034	30717996330035	0.26	1.60	12
16	NGLWCBD	NEW GEN W-LID COBALT BLU DECAF	\$7.30	717996332038	30717996332039	0.26	1.60	12
16	NGLWCOB	NEW GEN W-LID COUNTRY BLUE	\$7.30	717996330041	30717996330042	0.26	1.60	12
16	NGLWCOBD	NEW GEN W-LID CNTRY BLU DECAF	\$7.30	717996332045	30717996332046	0.26	1.60	12
16	NGLWFG	NEW GEN W-LID FORREST GREEN	\$7.30	717996330058	30717996330059	0.26	1.60	12
16	NGLWFGD	NEW GEN W-LID FOR GREEN DECAF	\$7.30	717996332052	30717996332053	0.26	1.60	12
16	NGLWGR	NEW GEN WELDED LID GREY	\$7.30	717996330065	30717996330066	0.26	1.60	12
16	NGLWGRD	NEW GEN W-LID GREY DECAF	\$7.30	717996332069	30717996332060	0.26	1.60	12
16	NGLWH	NEW GEN LID WHITE	\$7.30	717996320134	30717996320135	0.26	1.60	12
16	NGLWHD	NEW GEN LID WHITE DECAF	\$7.30	717996322138	30717996322139	0.26	1.60	12
16	NGLWMV	NEW GEN WELDED LID MAUVE	\$7.30	717996330072	30717996330073	0.26	1.60	12
16	NGLWMVD	NEW GEN W-LID MAUVE DECAF	\$7.30	717996332077	30717996332078	0.26	1.60	12
16	NGLWOR	NEW GEN WELDED LID ORANGE	\$7.30	717996330300	30717996330301	0.26	1.60	12
16	NGLWWH	NEW GEN WELDED LID WHITE	\$7.30	717996330133	30717996330134	0.26	1.60	12
16	NGLWWHD	NEW GEN W-LID WHITE DECAF	\$7.30	717996332137	30717996332138	0.26	1.60	12
45	O22Y	GLASS LINER 2.2L FOR TES	\$31.80	717996250110	30717996250111	0.31	1.92	1
45	O25Y	GLASS LINER 2.5L FOR TES	\$31.80	717996250127	30717996250128	0.33	2.02	1
45	O30W	GLASS LINER 3L FOR TES	\$31.80	717996250134	30717996250135	0.37	2.32	1
49	OCH7715	OCTAGON COND HOLDER 7X7X17	\$122.00	717996246502	30717996246503	NA	NA	1
49	OCH7715C	OCT COND HLDR CLOSED 7X7X17	\$127.00	717996246519	30717996246510	NA	NA	1
44	OGH8811	ADJUSTABLE STAND FOR PNWA250	\$141.00	717996246526	30717996246527	NA	NA	NA
10	OT11BL	THERMO PLT HOLDER 11" BLACK	\$13.10	717996481019	30717996481010	0.54	12.40	12
10	OT11BLC	THERMO PLT HOLDER BLK W/ STEEL	\$39.30	717996480012	30717996480013	0.54	25.00	12
10	OT11SS	THERMO PLT INSERT 11" STEEL	\$26.20	717996481316	30717996481317	0.11	12.00	12
17	PB101BL	PUSH BTTN SERV 1L BLACK	\$30.10	717996080014	30717996080015	1.06	7.00	6
17	PB101CB	PUSH BTTN SERV 1L COPR/BLACK	\$30.10	717996080205	30717996080206	1.06	7.00	6
17	PB101KB	PUSH BTTN SERV 1L GOLD/BLACK	\$30.10	717996080281	30717996080282	1.06	7.00	6
17	PB101SB	PUSH BTTN SERV 1L SILVER/BLK	\$30.10	717996080298	30717996080299	1.06	7.00	6
17	PB101ST	PUSH BTTN SERV 1L STONE/BRN	\$30.10	717996080090	30717996080091	1.06	7.00	6
17	PB421BL	PUSH BTTN SERV 2L BLACK	\$41.00	717996110018	30717996110019	1.57	9.40	6
17	PB421CB	PUSH BTTN SERV 2L COPR/BLACK	\$41.00	717996110209	30717996110200	1.57	9.40	6
17	PB421KB	PUSH BTTN SERV 2L GOLD/BLACK	\$41.00	717996110285	30717996110286	1.57	9.40	6
17	PB421SB	PUSH BTTN SERV 2L SILVER/BLACK	\$41.00	717996110292	30717996110293	1.57	9.40	6
17	PB421ST/BR	PUSH BTTN SERV 2L STONE/BROWN	\$41.00	717996110094	30717996110095	1.57	9.40	6
17	PB501BL	PUSH BTTN SERV .6L BLACK	\$27.60	717996100010	30717996100011	0.67	6.40	6
17	PB501CB	PUSH BTTN SERV .6L COPR/BLACK	\$27.60	717996100200	30717996100201	0.67	6.40	6
17	PB501KB	PUSH BTTN SERV .6L GOLD/BLACK	\$27.60	717996100286	30717996100287	0.67	6.40	6
17	PB501SB	PUSH BTTN SERV .6L SILVER/BLAC	\$27.60	717996100293	30717996100294	0.67	6.40	6
17	PB501ST	PUSH BTTN SERV .6L STONE/BROWN	\$27.60	717996100095	30717996100096	0.67	6.40	6
38	PCB18	COFFEE DECANTR 1 PK BLK W/ORG	\$19.40	717996000500	30717996000501	2.62	11.00	12
45	PNUA220	2.2L BLACK AIRPOT W/SIGHTGLASS	\$106.70	717996250684	30717996250685	3.73	32.20	6
45	PNUA22L	BLACK REPL LID FOR PNUA220	\$24.40	717996250752	30717996250753	NA	3.00	1
45	PNUA300	3 L BLACK AIRPOT W/SIGHTGLASS	\$113.20	717996250691	30717996250692	4.28	35.60	6
45	PNUA3L	BLACK REPL LID FOR PNUA300	\$24.40	717996250769	30717996250760	NA	4.00	1
44	PNWA250	GRAVITY FEED 2.5L BREW THRU	\$103.40	717996250547	30717996250548	3.06	26.60	6
44	PNWABASE	PNWA BOTTOM AND SCREW	\$5.80	717996251131	30717996251132	NA	NA	1
44	PNWACASE	PNWA BODY CASE	\$23.00	717996251148	30717996251149	NA	NA	1
44	PNWACLIP	SIGNAGE FOR PNWA	\$19.20	717996250851	30717996250852	NA	0.05	1
44	PNWAFACE	PNWA PANL CAP,SPRING,MARK SI	\$5.80	717996251094	30717996251095	NA	NA	1
44	PNWAHNDL	PNWA HANDLE ONLY	\$5.80	717996250561	30717996250562	NA	0.10	1
44	PNWALEVER	PNWA LEVER ASSEMBLY	\$5.80	717996251100	30717996251101	NA	NA	1
44	PNWALID	PNWA LID	\$5.80					
44	PNWALINER	PNWA 2.5L LINER F/GRAVITY	\$28.80	717996250554	30717996250555	NA	1.00	1
44	PNWASGCAP	PNWA OUTER SIGHT GLASS CAP	\$5.80	717996250868	30717996250869	NA	NA	1
44	PNWASGK	PNWA SIGHT GLASS KIT	\$5.80	717996250615	30717996250616	NA	0.10	1
44	PNWASTD250	GRAVITY FEED 2.5L BREW THRU W/ STAND	\$121.30	717996250738	30717996250739	1.58	6.80	1
44	PNWAVLV	PNWA BOTTOM VALVE W/CAP	\$5.80	717996250622	30717996250623	NA	0.10	1
44	PNWAVTK	PNWA VALVE TUBING KIT 5 PCS	\$17.20	717996250639	30717996250630	NA	NA	1
22	PWLA061	.6L NSF STEELVAC S/S CARAFE	\$56.60	717996250912	30717996250913	0.80	8.40	6
22	PWLA121	1.2L NSF STEELVAC S/S CARAFE	\$61.40	717996250929	30717996250920	1.10	10.65	6
22	PWLA161	1.6L NSF STEELVAC S/S CARAFE	\$66.80	717996250936	30717996250937	1.25	11.95	6
22	PWLA201	2L NSF STEELVAC S/S CARAFE	\$72.00	717996250943	30717996250944	1.42	13.15	6
22	PWLBL	LID PUSHBUTTON FOR PWL CARAFE	\$7.30	717996250950	30717996250951	0.26	0.90	6
22	PWLBLD	LID ORANGE PUSHBUTTON DECAFPWL	\$7.30	717996250950	30717996250951	0.26	0.90	6
37	PWP19SB	POLYCARB PITCHER 1.9L SMOOTH	\$30.40	717996274253	30717996274254	1.78	10.80	6
37	PWP28BS	POLYCARB PITCHR 2.8L BELL SHAP	\$33.70	717996274260	30717996274261	2.29	13.00	6
37	PWP33SB	POLYCARB PITCHER 3.3L SMOOTH	\$34.80	717996274277	30717996274278	2.29	13.00	6
30	PXS19BTL	ULTRA CARAFE 1.9L S/S W/BTL	\$44.10	717996250332	30717996250333	2.43	20.00	6
30	PXS19C	ULTRA CARAFE 1.9L S/S W/CLICK LID	\$44.10	717996250356	30717996250357	2.43	20.00	6
30	PXSBTL	BREW THRU LID FOR PXS19BTL	\$7.30	717996250387	30717996250388	0.26	5.00	12
30	PXSBTLOR	BREW THRU LID DECAF FOR PXS	\$7.30	717996250394	30717996250395	0.26	5.00	12

PAGE	PRODUCT CODE	PRODUCT DESCRIPTION	2008 LIST EACH PRICE	PRODUCT UPC	CASE UPC	CUBE	CASE WT.	CASE QTY
30	PXSL	CLICK LID FOR PXSL19	\$7.30	717996250363	30717996250364	0.26	5.00	12
30	PXSRL19	ULTRA GLASS LINER 1.9L	\$16.60	717996250400	30717996250401	NA	1.75	1
10	RO117BL	THERMO PLT HLDR W/HNDL BLK	\$12.30	717996501014	30717996501015	0.80	9.20	12
10	RO117BLAC	THERMO PLT COMP HLDR HNDL BLK W/AL	\$41.80	717996500086	30717996500087	0.80	30.00	12
10	RO117BLC	THERMO PLT COMP HLDR HNDL BLK W/SS	\$47.30	717996500077	30717996500078	0.80	30.00	12
10	RO128BL	THERMO PLT HLDR OVAL BLACK	\$15.50	717996511013	30717996511014	0.80	17.00	12
10	RO128BLC	THERMO PLT COMP OVAL BLK W/SS	\$52.30	717996510016	30717996510017	0.80	30.00	12
10	RO128SS	THERMO PLT INSERT OVAL S/S	\$36.80	717996511310	30717996511311	0.13	13.00	12
47	RRA3	ROTO RACK FOR 1-3 AIRPOTS	\$350.00	717996246038	30717996246039	1.22	12.20	1
47	RRA3C	ROTO RACK 3 POT, SIGN, DRIP TRAYS	\$420.00	717996246113	30717996246114	4.60	21.00	1
47	RRA6	ROTO RACK FOR 1-6 AIRPOTS	\$390.00	717996246045	30717996246046	1.90	18.60	1
47	RRA6C	ROTO RACK 6 POT, SIGN, DRIP TRAYS	\$460.00	717996246076	30717996246077	NA	27.60	1
47	RRKIT3	RR3KIT, 3 OCT DRIP TRAY & HDWE	\$72.00	707996246106	30717996246107	0.12	1.60	1
47	RRSIGNKIT	SIGNHOLDER POLE, TOPPER RRA3&6	\$110.00	717996246061	30717996246062	2.04	6.40	1
47	RRTOOL	ROTO RACK HEX WRENCH	\$3.00	717996246120	30717996246121	NA	NA	1
10	RT1025BL	THERMO PLT HOLDER 10.25" BLACK	\$14.30	717996521012	30717996521013	0.88	15.00	12
10	RT1025BLC	THERMO PLT COMP 10.25 HLDR BLK W/SS	\$52.40	717996520015	30717996520016	0.88	30.00	12
10	RT1025SS	THERMO PLT INSERT 10.25" S/S	\$35.00	717996521319	30717996521310	0.17	14.00	12
10	RT10BL	THERMO PLT HOLDER 10" BLACK	\$17.40	717996531011	30717996531012	0.88	15.00	12
10	RT10BLC	THERMO PLT COMP 10 HLDR BLK W/SS	\$49.10	717996530014	30717996530015	0.88	30.00	12
10	RT10SS	THERMO PLT INSERT 10" S/S	\$35.00	717996531318	30717996531319	0.17	14.00	12
10	RT701BL	THERMO PLT HOLDER 7" BLACK	\$14.80	717996541010	30717996541011	0.52	11.00	12
10	RT701BLC	THERMO PLT COMP 7 HLDR BLK W/ SS	\$34.50	717996540013	30717996540014	0.52	18.00	12
10	RT7BL	THERMO PLT HLDR 7" SLOPE BLK	\$14.80	717996551010	30717996551011	0.52	10.00	12
10	RT7BLC	THERMO PLT COMP 7 SLOPE BLK W/SS	\$34.50	717996550210	30717996550211	0.52	18.00	12
10	RT7SS	THERMO PLT INSERT 7" S/S	\$19.70	717996551316	30717996551317	0.07	8.00	12
10	RTE7SS	THERMO PLT INSRT 7" ESCARG S/S	\$22.00	717996553310	30717996553311	0.07	8.00	12
10	RTO10SS	THERMO PLT INSR 10" OYSTR S/S	\$38.20	717996533312	30717996533313	0.15	16.00	12
23	S2S100	STEELVAC 1L STAINLESS W/O BASE	\$43.60	717996216314	30717996216315	1.10	9.80	6
23	S2S100E2%	STEELVAC 1L STACKED 2% MILK	\$50.60	717996211432	30717996211433	1.10	9.80	6
23	S2S100EHH	STEELVAC 1L STACKED HALF&HALF	\$50.60	717996211449	30717996211440	1.10	9.80	6
23	S2S100ESM	STEELVAC 1L STACKED SKIM MILK	\$50.60	717996211456	30717996211457	1.10	9.80	6
23	S2S70	STEELVAC .7 LITER STAINLESS	\$39.80	717996216307	30717996216308	0.90	8.40	6
23	SB100	STEELVAC 1L BLACK W/BASE	\$43.60	717996211012	30717996211013	1.10	9.60	6
23	SB70	STEELVAC .7L BLACK W/BASE	\$39.80	717996212019	30717996212010	0.90	8.40	6
49	SCI090	6 COMP CONDIMENT CADDY BLK PLS	\$13.65	717996246014	30717996246015	3.92	22.00	24
19	SCICA	COLD PACK-STATIC CLING LABELS	\$5.50	717996245017	30717996245018	NA	0.10	1
19	SCIHA	HOT PACK-STATIC CLING LABELS	\$5.50	717996245024	30717996245025	NA	0.10	1
19	SCIVPA	STATIC CLING LABELS -VARIETY P	\$5.50	717996245031	30717996245032	NA	0.10	1
14	SC85	S/S CREAMER ONLY 8.5 OZ	\$12.30	717996212491	30717996212492	0.04	0.15	1
14	SC85GAS	SC85 CREAMER GASKET ONLY	\$2.10	717996212538	30717996212539	NA	0.01	1
43	SECA19S	ECO-AIR 1.9 LITER STAINLESS	\$69.80	717996237203	30717996237204	2.65	23.80	6
43	SECA22S	ECO-AIR 2.2 LITER S/S LINED	\$72.70	717996237210	30717996237211	2.63	24.30	6
43	SECA25S	ECO-AIR 2.5 LITER STAINLESS	\$75.70	717996237227	30717996237228	2.98	24.80	6
43	SECA30S	ECO-AIR 3 LITER STAINLESS	\$79.90	717996237234	30717996237235	3.02	27.80	6
43	SECAL19S	ECO-AIR 1.9 LITER STAINLESS LEVER	\$69.80	717996236442	30717996236443	2.65	23.80	6
43	SECAL22S	ECO-AIR 2.2 LITER S/S LINED LEVER	\$72.70	717996236459	30717996236450	2.63	24.30	6
43	SECAL25S	ECO-AIR 2.5 LITER STAINLESS LEVER	\$75.70	717996236466	30717996236467	2.98	24.80	6
43	SECAL30S	ECO-AIR 3 LITER STAINLESS LEVER	\$79.90	717996236473	30717996236474	3.02	27.80	6
43	SESP19	SUCTION PIPE 1.9L SECA	\$10.40	717996238781	30717996238782	1.18	2.00	1
43	SESP22	SUCTION PIPE 2.2L SECA	\$10.40	717996237944	30717996237945	NA	0.10	1
43	SESP25	SUCTION PIPE 2.5L SECA	\$10.40	717996237746	30717996237747	NA	0.10	1
43	SESP3	SUCTION PIPE 3L SECA	\$10.40	717996237197	30717996237198	NA	0.15	1
37	SI2LITCL	CLEAR PITCHER 2 LITER W/LID	\$23.50	717996437344	30717996437345	1.13	7.40	6
37	SI2LITCOC	CLEAR PITCHER COVER FOR SI2LITC	\$4.50	717996406340	30717996406341	NA	0.15	1
23	SJ10SS	STEELVAC-PUSHBTN 1 LITER SLIM	\$51.20	717996212361	30717996212362	1.05	12.00	6
23	SJ20SS	STEELVAC-PUSHBTN 2 LITER SLIM	\$68.40	717996212378	30717996212379	1.72	17.60	6
23	SJ60SS	STEELVAC-PUSHBUTTON .6 LITER	\$46.50	717996212330	30717996212331	0.97	9.50	6
23	SJBTL	SJ BREW-THRU LID BLACK	\$7.30	717996212385	30717996212386	0.26	1.80	12
23	SJBTLOR	SJ BREW-THRU LID ORANGE	\$7.30	717996212392	30717996212393	0.26	1.80	12
23	SJL	SJ LID BLACK TRIGGER	\$7.30	717996212408	30717996212409	0.26	1.80	12
23	SJLOR	SJ LID ORANGE TRIGGER	\$7.30	717996212415	30717996212416	0.26	1.80	12
12	SK107BH	THERMO PLT FAJITA HOLDER BIRCH	\$21.90	717996461394	30717996461395	0.98	12.00	12
12	SK107BHC	THERMO PLT COMP BIRCH	\$46.60	717996460397	30717996460398	1.72	26.00	12
12	SK107CA	THERMO PLT FAJITA SKILLET ALUM	\$24.70	717996461462	30717996461463	0.63	13.90	12
12	SK10CI	CAST IRON SKILLET W/O HANDLE	\$15.90	717996461479	30717996461470	1.06	16.00	6
12	SK10CIH	CAST IRON SKILLET WITH HANDLE	\$20.30	717996461486	30717996461487	1.06	21.00	6
14	SLC85	S/S CREAMER REPL LID/GASKET	\$4.10	717996212514	30717996212515	NA	0.10	1
14	SLS85	S/S SUGAR REPL LID ONLY	\$4.10	717996212521	30717996212522	NA	0.10	1
52	SPIGOT	ZEPE' REPLACEMENT SPIGOT	\$28.60	717996274093	30717996274094	NA	0.20	1
52	SPIGOT807	ZEPE' REPLACEMENT SPIGOT 807 SERIES	\$22.00	717996271139	30717996271130	NA	0.20	1

PAGE	PRODUCT CODE	PRODUCT DESCRIPTION	2008 LIST EACH PRICE	PRODUCT UPC	CASE UPC	CUBE.	CASE WT.	CASE QTY
23	SS100	STEELVAC 1L STAINLESS W/BASE	\$36.60	717996211319	30717996211310	1.13	11.00	6
23	SS100D	STEELVAC 1L STAINLESS W/BASE DECAF	\$36.60	717996211319	30717996211310	1.13	11.00	6
23	SS100HALF	STEELVAC 1L STACKED HALF&HALF	\$43.60	717996211401	30717996211402	1.13	12.00	6
23	SS100SKIM	STEELVAC 1L STACKED SKIM MILK	\$43.60	717996211418	30717996211419	1.13	12.00	6
23	SS100WHOLE	STEELVAC 1L STACKED WHOLE MILK	\$43.60	717996211425	30717996211426	1.13	12.00	6
23	SS70	STEELVAC .7L STAINLESS W/BASE	\$33.40	717996212316	30717996212317	0.95	10.00	6
14	SS85	S/S SUGAR ONLY 8.5 OZ	\$12.30	717996212507	30717996212508	0.04	0.15	1
46	SSA250	STEELVAC 2.5L S/S	\$103.00	717996238002	30717996238003	3.63	35.00	6
46	SSA300	STEELVAC 3 LITER S/S	\$107.30	717996238019	30717996238010	3.86	38.20	6
45	SSA300SG	STEELVAC 3L S/S W/SIGHT GLASS	\$137.80	717996238200	30717996238201	3.86	40.20	6
46	SSA375	STEELVAC 3.75 LITER S/S	\$121.40	717996238026	30717996238027	4.27	40.70	6
46	SSAL250	STEELVAC 2.5L S/S LEVER	\$103.00	717996238163	30717996238164	3.63	35.00	6
46	SSAL300	STEELVAC 3L S/S LEVER	\$107.30	717996238217	30717996238218	3.86	38.20	6
45	SSAL300SG	STEELVAC 3L S/S W/SIGHT GL/LEVER	\$137.60	717996238217	30717996238218	3.86	38.20	6
46	SSAL375	STEELVAC 3.75L S/S LEVER	\$121.40	717996238101	30717996238102	4.27	40.70	6
45	SSALL	SSA REPLACEMENT LEVER LID 2-5	\$25.60	717996238040	30717996238041	NA	0.40	1
45	SSALLOR	SSA REPLACEMENT LEVER ORANGE L	\$25.60	717996991358	30717996991359	NA	0.50	1
45	SSALOR	SSA REPLACEMENT ORANGE PUMP 2.	\$25.60	717996991365	30717996991366	NA	0.70	1
45	SSAPL	SSA REPLACEMENT PUMP LID 2.5 L	\$25.60	717996238033	30717996238034	NA	0.70	1
45	SSASGC	SSA300SG SIGHT GLASS COVR&BRSH	\$8.30	717996238798	30717996238799	NA	0.20	1
46	SSASP250	SSA REPLACEMENT SUCTION PIPE 2	\$10.80	717996238057	30717996238058	NA	0.10	1
45	SSASP300	SSA REPLACEMENT SUCTION PIPE 3	\$10.80	717996238064	30717996238065	NA	0.15	1
46	SSASP375	SSA REPLACEMENT SUCTION PIPE 3	\$10.80	717996238071	30717996238072	NA	0.15	1
14	SSC85	SUGAR/CREAMER SET S/S 8.5 OZ	\$24.50	717996212446	30717996212447	1.80	18.00	24
23	SSLID	STEELVAC REPLACEMENT LID	\$7.30	717996410019	30717996410010	0.26	2.00	6
23	SSLIDOR	STEELVAC REPLACEMENT LID ORANG	\$7.30	717996210336	30717996210337	0.26	2.00	6
18	SSS20BL	SI SWIRL STYLE SERV 20 OZ BLK	\$17.20	717996145003	30717996145004	NA	NA	12
18	SSS20GM	SI SWIRL STYLE SERV 20 OZ GUN	\$18.90	717996145010	30717996145011	NA	NA	12
18	SSS20MO	SI SWIRL STYLE SERV 20 OZ MOC	\$18.90	717996145027	30717996145028	NA	NA	12
18	SSS20WH	SI SWIRL STYLE SERV 20 OZ WHT	\$17.20	717996145010	30717996145035	NA	NA	12
18	SSS42BL	SI SWIRL STYLE SERV 42 OZ BLK	\$19.40	717996145041	30717996145042	NA	NA	12
18	SSS42GM	SI SWIRL STYLE SERV 42 OZ GUN	\$21.30	717996145058	30717996145059	NA	NA	12
18	SSS42MO	SI SWIRL STYLE SERV 42 OZ MOC	\$21.30	717996145065	30717996145066	NA	NA	12
18	SSS42WH	SI SWIRL STYLE SERV 42 OZ WHT	\$19.40	717996145072	30717996145073	NA	NA	12
18	SSS64BL	SI SWIRL STYLE SERV 64 OZ BLK	\$30.40	717996145089	30717996145080	NA	NA	6
18	SSS64GM	SI SWIRL STYLE SERV 64 OZ GUN	\$33.40	717996145096	30717996145097	NA	NA	6
18	SSS64MO	SI SWIRL STYLE SERV 64 OZ MOC	\$33.40	717996145102	30717996145103	NA	NA	6
18	SSS64WH	SI SWIRL STYLE SERV 64 OZ WHT	\$30.40	717996145119	30717996145110	NA	NA	6
18	SSSFTVAR	SI SWIRL COFFEE INDICATR BRN, GRN, ORG	\$3.00					
18	SSSL20BL	SI SWIRL LID ONLY 20 OZ BLACK	\$4.50	717996145126	30717996145127	NA	NA	12
18	SSSL20GM	SI SWIRL LID ONLY 20 OZ GUNMT	\$4.50	717996145133	30717996145134	NA	NA	12
18	SSSL20MO	SI SWIRL LID ONLY 20 OZ MOCHA	\$4.50	717996145140	30717996145141	NA	NA	12
18	SSSL20WH	SI SWIRL LID ONLY 20 OZ WHITE	\$4.50	717996145157	30717996145158	NA	NA	12
18	SSSL42BL	SI SWIRL LID ONLY 42 OZ BLACK	\$4.50	717996145164	30717996145165	NA	NA	12
18	SSSL42GM	SI SWIRL LID ONLY 42 OZ GUNMT	\$4.50	717996145171	30717996145172	NA	NA	12
18	SSSL42MO	SI SWIRL LID ONLY 42 OZ MOCHA	\$4.50	717996145188	30717996145189	NA	NA	12
18	SSSL42WH	SI SWIRL LID ONLY 42 OZ WHITE	\$4.50	717996145195	30717996145196	NA	NA	12
18	SSSL64BL	SI SWIRL LID ONLY 64 OZ BLACK	\$4.50	717996145201	30717996145202	NA	NA	12
18	SSSL64GM	SI SWIRL LID ONLY 64 OZ GUNMT	\$4.50	717996145218	30717996145219	NA	NA	12
18	SSSL64MO	SI SWIRL LID ONLY 64 OZ MOCHA	\$4.50	717996145225	30717996145226	NA	NA	12
18	SSSL64WH	SI SWIRL LID ONLY 64 OZ WHITE	\$4.50	717996145232	30717996145233	NA	NA	12
13	STC3	S/S CONDIMENT 3 HOLE	\$15.50	717996406395	30717996406396	0.26	2.65	6
13	STC7	S/S CONDIMENT 7 HOLE	\$15.50	717996406401	30717996406402	0.26	2.65	6
13	STC7VANILLA	S/S COND 7 HOLE VANILLA IMPR	\$16.90	717996406418	30717996406419	0.26	2.65	6
13	STCMESH	S/S CONDIMENT MESH TOP	\$15.90	717996406425	30717996406426	0.26	2.65	6
13	STCMESHNUTM	S/S COND MESH NUTMEG IMPRINT	\$16.90	717996406449	30717996406440	0.26	2.65	6
13	STCMESHPSUGR	S/S COND MESH POW SUGR IMPRINT	\$16.90	717996406432	30717996406433	0.26	2.65	6
13	STCMULTI	S/S CONDIMENT MULTI HOLE	\$15.90	717996406456	30717996406457	0.26	2.65	6
13	STCMULTICINN	S/S COND MULTI CINNAMON IMPRINT	\$16.90	717996406463	30717996406464	0.26	2.65	6
13	STCTEAR	S/S CONDIMENT TEARDROP TOP	\$15.90	717996406470	30717996406471	0.26	2.65	6
13	STCTEARCOCOA	S/S COND TEARDROP COCOA IMPRINT	\$16.90	717996406487	30717996406488	0.26	2.65	6
13	STOCFCR	S/S COND SET 4 CMP W/FLAVORS	\$72.20	717996406364	30717996406365	4.00	41.80	12
13	STOCFF	S/S CONDIMENT COFFEE SET 4 PCK	\$65.60	717996406517	30717996406518	4.00	41.80	12
13	STOCPSCR	S/S COND SET 2 CMP W/CIN, PSUG	\$58.70	717996406388	30717996406389	2.60	34.20	20
13	STOH2	S/S CONDIMENT CADDY 2 COMPARTMENT	\$18.70	717996406494	30717996406495	2.60	16.00	20
13	STOH4	S/S CONDIMENT CADDY 4 COMPARTMENT	\$30.10	717996406500	30717996406501	4.00	20.20	12
20	STOPPER	LID STOPPER .8L - 2L ALFI	\$14.70	717996224654	30717996224655	NA	0.08	1
20	STOPPER2	LID STOPPER .32L -.75L ALFI	\$14.70	4002458130618	04002458130618	NA	0.08	1
13	STOSPSH	S/S SALT & PEPPER SHAKER SET	\$55.50	717996406371	30717996406372	2.60	34.20	20
23	SW100	STEELVAC 1L WHITE W/BASE	\$43.60	717996211135	30717996211136	1.05	9.40	6
23	SW70	STEELVAC .7L WHITE W/BASE	\$39.80	717996212132	30717996212133	0.84	5.20	6

PAGE	PRODUCT CODE	PRODUCT DESCRIPTION	2008 LIST EACH PRICE	PRODUCT UPC	CASE UPC	CUBE	CASE WT.	CASE QTY
14	SY916AL	SYRUP DISP 16 OZ ALMOND/CLR	\$11.20	717996190003	30717996190004	0.30	2.00	6
14	SY916BL	SYRUP DISP 16 OZ BLACK/CLR	\$11.20	717996190010	30717996190011	0.30	2.00	6
14	SY916WH	SYRUP DISP 16 OZ WHITE	\$11.20	717996190034	30717996190035	0.30	2.00	6
14	SYLAL	SY DISP LID ALMOND	\$4.10	717996290000	30717996290001	0.26	0.70	12
14	SYLBL	SY DISP LID BLACK	\$4.10	717996290017	30717996290018	0.26	0.70	12
14	SYLWH	SY DISP LID WHITE	\$4.10	717996290031	30717996290032	0.26	0.70	12
14	SZ10BL	SY DISP 10 OZ BLK 'NO FLAVOR'	\$10.90	717996194070	30717996194071	0.40	2.60	12
14	SZ10BLBLU	SY DISP 10 OZ BLK W/BLUEBERRY	\$11.40	717996194001	30717996194002	0.40	2.60	12
14	SZ10BLBP	SY DISP 10 OZ BLK W/BTR PECAN	\$11.40	717996194018	30717996194019	0.40	2.60	12
14	SZ10BLBY	SY DISP 10 OZ BLK W/BOYSENBERY	\$11.40	717996194025	30717996194026	0.40	2.60	12
14	SZ10BLST	SY DISP 10 OZ BLK W/STRAWBERRY	\$11.40	717996194063	30717996194064	0.40	2.60	12
14	SZ10RED	SY DISP 10 OZ RED 'NO FLAVOR'	\$10.90					
14	SZ10YL	SY DISP 10 OZ YELLOW 'NO FLAVOR'	\$10.90					
14	SZC4	SYRUP DISP CADDY BLACK/COPPER	\$31.40	717996195008	30717996195009	0.42	3.60	4
14	SZJ10CL	SYRUP DISP JAR ONLY 10 OZ CLR	\$7.70	717996199976	30717996199977	0.40	1.90	12
14	SZLBL	SY DISP LID BLACK W/NO FLAVOR	\$4.10	717996196074	30717996196075	0.16	1.20	12
14	SZLBLBLU	SY DISP LID BLACK W/BLUEBERRY	\$5.50	717996196005	30717996196006	0.16	1.20	12
14	SZLBLBP	SY DISP LID BLACK W/BTR PECAN	\$5.50	717996196012	30717996196013	0.16	1.20	12
14	SZLBLBY	SY DISP LID BLACK W/BOYSENBERY	\$5.50	717996196029	30717996196020	0.16	1.20	12
14	SZLBLST	SY DISP LID BLACK W/STRAWBERRY	\$5.50	717996196067	30717996196068	0.16	1.20	12
14	SZLRED	SY DISP LID RED W/NO FLAVOR	\$4.10	717996196074	30717996196075	0.16	1.20	12
14	SZLYL	SY DISP LID YELLOW W/NO FLAVOR	\$4.10	717996196074	30717996196075	0.16	1.20	12
14	SZS4	SYRUP DISP CADDY BLACK & S/S	\$29.90	717966195015	30717966195016	0.42	3.60	4
32	T277B	COFFEE PRESS 350 ML BRICK/CH	\$29.90	717996230501	30717996230502	4.09	13.44	12
32	T477B	COFFEE PRESS 600 ML BRICK/CH	\$35.20	717996230549	30717996230540	1.91	20.00	12
33	T600CC	COFFEE TEA PRESS 4 CUP CHROME	\$29.60	717996224951	30717996224952	2.24	15.00	12
33	T600CCG	COFFEE TEA PRESS 4 CUP GOLD	\$37.20	717996224968	30717996224969	2.24	15.00	12
32	T677B	COFFEE PRESS 800 ML BRICK/CH	\$47.00	717996230518	30717996230519	2.36	22.20	12
34	TB006	TEABOX 6 COMP BEECH WOOD	\$33.80	8711871027806	08711871027806	2.00	24.40	12
34	TB012	TEABOX 12 COMP BEECH WOOD	\$55.70	8711871027851	08711871027851	1.83	21.00	6
36	TB1200CC	TEA BALL 1.2L 40oz BLACK	\$25.30	717996230532	30717996230533	2.25	16.20	12
36	TB600BSK	INFUSER BASKET	\$3.00(NET)					
36	TB600CC	COFFEE TEA PRESS 600ML BLACK	\$19.50	717996237333	30717996237334	2.75	21.80	24
45	TES22	PREMIUM PUMP 2.2L SS/BL	\$78.30	717996250004	30717996250005	3.67	29.00	6
45	TES25	PREMIUM PUMP 2.5L SS/BL	\$80.60	717996250011	30717996250012	3.93	30.20	6
45	TES30	PREMIUM PUMP 3L SS/BL	\$84.10	717996250028	30717996250029	4.18	35.00	6
	TESGAS	TES LINER GASKET						
45	TESL22	PREMIUM LEVER 2.2L SS/BL	\$78.30	717996250417	30717996250418	3.67	29.00	6
45	TESL25	PREMIUM LEVER 2.5L SS/BL	\$80.60	717996250424	30717996250425	3.93	30.20	6
45	TESL30	PREMIUM LEVER 3L SS/BL	\$84.10	717996250431	30717996250432	4.19	35.00	6
45	TESLID	PREMIUM PUMP LID 2.2-3L SS/BL	\$24.40	717996250141	30717996250142	NA	0.50	1
45	TESLIDOR	PREM PUMP LID 2.2-3L ORANGE	\$24.40	717996250240	30717996250241	NA	0.50	1
45	TESLL	PREMIUM LEVER LID 2.2-3L SS/BL	\$24.40	717996250455	30717996250456	NA	0.50	1
45	TESLLOR	PREMIUM LEVER LID 2.2-3L ORANG	\$24.40	717996250462	30717996250463	NA	0.50	1
45	TESP22	SUCTION PIPE 2.2L FOR TES22	\$10.30	717996250165	30717996250166	NA	0.10	1
45	TESP25	SUCTION PIPE 2.5L FOR TES25	\$10.30	717996250172	30717996250173	NA	0.10	1
45	TESP30	SUCTION PIPE 3L FOR TES30	\$10.30	717996250189	30717996250180	NA	0.10	1
36	TETHER	TST612 REPLACEMENT TETHER	\$1.00	717996390649	30717996390640	NA	0.01	1
33	TL4	GLASS LINER FOR T600CC 20 OZ.	\$12.50	717996224685	30717996224686	1.99	13.00	24
19	TNS20BL	TWIST-N-SERV 20 OZ BLACK	\$15.60	717996015009	30717996015000	1.55	13.00	12
19	TNS20WH	TWIST-N-SERV 20 OZ WHITE	\$15.60	717996015016	30717996015017	1.55	13.00	12
19	TNS40BL	TWIST-N-SERV 40 OZ BLACK	\$17.10	717996015023	30717996015024	3.00	23.20	12
19	TNS40WH	TWIST-N-SERV 40 OZ WHITE	\$17.10	717996015030	30717996015031	3.00	23.20	12
19	TNS60BL	TWIST-N-SERV 60 OZ BLACK	\$27.60	717996015047	30717996015048	4.76	33.00	12
19	TNS60WH	TWIST-N-SERV 60 OZ WHITE	\$27.60	717996015054	30717996015055	4.76	33.00	12
19	TNSL20BL	TWIST-N-SERV LID 20 OZ BLACK	\$4.50	717996015061	30717996015062	0.26	1.20	12
19	TNSL20WH	TWIST-N-SERV LID 20 OZ WHITE	\$4.50	717996015078	30717996015079	0.26	1.20	12
19	TNSL40BL	TWIST-N-SERV LID 40 OZ BLACK	\$4.50	717996015085	30717996015086	0.26	1.80	12
19	TNSL40WH	TWIST-N-SERV LID 40 OZ WHITE	\$4.50	717996015092	30717996015093	0.26	1.80	12
19	TNSL60BL	TWIST-N-SERV LID 60 OZ BLACK	\$4.50	717996015108	30717996015109	0.26	2.40	12
19	TNSL60WH	TWIST-N-SERV LID 60 OZ WHITE	\$4.50	717996015115	30717996015116	0.26	2.40	12
19	TNSPB20BL	TWIST-N-SERV PUSH/B 20 OZ BLAC	\$17.20	717996015139	30717996015130	1.55	13.20	12
19	TNSPB20WH	TWIST-N-SERV PUSH/B 20 OZ WHIT	\$17.20	717996015146	30717996015147	1.55	13.20	12
19	TNSPB40BL	TWIST-N-SERV PUSH/B 40 OZ BLAC	\$19.40	717996015153	30717996015154	3.00	23.20	12
19	TNSPB40WH	TWIST-N-SERV PUSH/B 40 OZ WHIT	\$19.40	717996015160	30717996015161	3.00	23.20	12
19	TNSPB60BL	TWIST-N-SERV PUSH/B 60 OZ BLAC	\$30.40	717996015177	30717996015178	4.76	31.40	12
19	TNSPB60WH	TWIST-N-SERV PUSH/B 60 OZ WHIT	\$30.40	717996015184	30717996015185	4.76	31.40	12
19	TNSPBL20BL	TWST-N-SERV PUSH/B LID 20 OZ B	\$4.50	717996015290	30717996015291	0.26	1.20	12
19	TNSPBL20WH	TWST-N-SERV PUSH/B LID 20 OZ W	\$4.50	717996015306	30717996015307	0.26	1.20	12
19	TNSPBL40BL	TWST-N-SERV PUSH/B LID 40 OZ B	\$4.50	717996015214	30717996015215	0.26	1.80	12
19	TNSPBL40WH	TWST-N-SERV PUSH/B LID 40 OZ W	\$4.50	717996015221	30717996015222	0.26	1.80	12

PAGE	PRODUCT CODE	PRODUCT DESCRIPTION	2008 LIST EACH PRICE	PRODUCT UPC	CASE UPC	CUBE.	CASE WT.	CASE QTY
19	TNSPBL60BL	TWST-N-SERV PUSH/B LID 60 OZ B	\$4.50	717996015238	30717996015239	0.26	2.40	12
19	TNSPBL60WH	TWST-N-SERV PUSH/B LID 60 OZ W	\$4.50	717996015245	30717996015246	0.26	2.40	12
39	TONGS	IBT12CH S/S REPLACEMENT TONGS	\$4.50	717996430185	30717996430186	NA	NA	1
36	TPC10BL	TEAPOT 10 OZ BLACK CERAMIC	\$14.20	717996237494	30717996237495	0.35	4.80	6
36	TPC10FG	TEAPOT 10 OZ FOREST GN CERAMIC	\$14.20	717996237500	30717996237501	0.35	4.80	6
36	TPC10WH	TEAPOT 10 OZ WHITE CERAMIC	\$14.20	717996237524	30717996237525	0.35	4.80	6
36	TPC16BL	TEAPOT 16 OZ BLACK CERAMIC	\$19.60	717996237531	30717996237532	0.41	5.80	6
36	TPC16FG	TEAPOT 16 OZ FOREST GN CERAMIC	\$19.60	717996237548	30717996237549	0.41	5.80	6
36	TPC16WH	TEAPOT 16 OZ WHITE CERAMIC	\$19.60	717996237562	30717996237563	0.41	5.80	6
36	TPCBSK	CERAMIC TEAPOT BASKET ONLY	\$3.00	717996219008	30717996219009	NA	0.01	1
36	TPCLSS	STAINLESS CLIP-ON LID FOR TPC	\$4.50	717996237579	30717996237570	0.26	1.20	12
36	TPLAL	TS612 TEAPOT LID ALMOND	\$4.50	717996390441	30717996390442	0.26	0.60	12
36	TPLBL	TS612 TEAPOT LID BLACK	\$4.50	717996390458	30717996390459	0.26	0.60	12
36	TPLBR	TS612 TEAPOT LID BROWN	\$4.50	717996390465	30717996390466	0.26	0.60	12
36	TPLBU	TS612 TEAPOT LID BURGUNDY	\$4.50	717996390472	30717996390473	0.26	0.60	12
36	TPLCBT	TS612 TEAPOT LID COBALT BLUE	\$4.50	717996390489	30717996390480	0.26	0.60	12
36	TPLCOB	TS612 TEAPOT LID COUNTRY BLUE	\$4.50	717996390496	30717996390497	0.26	0.60	12
36	TPLFG	TS612 TEAPOT LID FOREST GREEN	\$4.50	717996390502	30717996390503	0.26	0.60	12
36	TPLGR	TS612 TEAPOT LID GRAY	\$4.50	717996390519	30717996390510	0.26	0.60	12
36	TPLMV	TS612 TEAPOT LID MAUVE	\$4.50	717996390526	30717996390527	0.26	0.60	12
36	TPLTAL	TST612 TEAPOT LID ALMOND	\$4.50	717996390540	30717996390541	0.26	0.60	12
36	TPLTBL	TST612 TEAPOT LID BLACK	\$4.50	717996390557	30717996390558	0.26	0.60	12
36	TPLTBR	TST612 TEAPOT LID BROWN	\$4.50	717996390564	30717996390565	0.26	0.60	12
36	TPLTBU	TST612 TEAPOT LID BURGUNDY	\$4.50	717996390571	30717996390572	0.26	0.60	12
36	TPLTCBT	TST612 TEAPOT LID COBALT BLUE	\$4.50	717996390588	30717996390589	0.26	0.60	12
36	TPLTCOB	TST612 TEAPOT LID COUNTRY BLUE	\$4.50	717996390595	30717996390596	0.26	0.60	12
36	TPLTFG	TST612 TEAPOT LID FOREST GREEN	\$4.50	717996390601	30717996390602	0.26	0.60	12
36	TPLTGR	TST612 TEAPOT LID GRAY	\$4.50	717996390618	30717996390619	0.26	0.60	12
36	TPLTMV	TST612 TEAPOT LID MAUVE	\$4.50	717996390625	30717996390626	0.26	0.60	12
36	TPLTQTZ	TST612 TEAPOT LID QUARTZ	\$4.50	717996390724	30717996390725	0.26	0.60	12
36	TPLTRUBY	TST612 TEAPOT LID RUBY	\$4.50	717996390717	30717996390718	0.26	0.60	12
36	TPLTSPH	TST612 TEAPOT LID SAPHIRE	\$4.50	717996390694	30717996390695	0.26	0.60	12
36	TPLTWH	TST612 TEAPOT LID WHITE	\$4.50	717996390632	30717996390633	0.26	0.60	12
36	TPLWH	TS612 TEAPOT LID WHITE	\$4.50	717996390533	30717996390534	0.26	0.60	12
30	TPS10	PUSH-N-SERV 1L SS/BLACK	\$42.00	717996250042	30717996250043	1.62	15.40	6
30	TPS16	PUSH-N-SERV 1.6L SS/BLACK	\$49.90	717996250059	30717996250050	1.92	18.20	6
30	TPS19	PUSH-N-SERV 1.9L SS/BLACK	\$55.00	717996250066	30717996250067	2.05	20.00	6
30	TPSGAS	LINER GASKET FOR TPS10-19	\$2.30	717996250523	30717996250524	NA	0.02	1
30	TPSLID	LID 1.0-1.9L FOR TPS SS/BLACK	\$7.30	717996250158	30717996250159	0.26	0.60	6
30	TPSLIDOR	POUR LID 1.0-1.9L SS/BL ORANGE	\$7.30	717996237807	30717996237808	0.26	0.60	6
39	TR1412	S/S STACKABLE TRAY 14X12X.75	\$45.10	717996238613	30717996238614	2.93	26.00	12
39	TR1412RI	S/S TRAY W/REMOVABLE INSERT 14X12X.75	\$45.10	717996238767	30717996238768	1.98	26.00	12
39	TR1412SR	S/S TRAY SOLID RUBBR 14X12X.75	\$45.10	717996238682	30717996238683	1.98	26.00	12
39	TR-RI	RUBBER INSERT FOR TR1412RI	\$9.90					
18	TS101BL	FLIP-TOP 1L BLACK	\$27.60	717996120017	30717996120018	1.06	7.30	6
18	TS101CB	FLIP-TOP 1L COPPER/BLACK	\$27.60	717996120208	30717996120209	1.06	7.30	6
18	TS101KB	FLIP-TOP 1L GOLD/BLACK	\$27.60	717996120284	30717996120285	1.06	7.30	6
18	TS411BL	FLIP-TOP 2L BLACK	\$39.10	717996130016	30717996130017	1.59	9.20	6
18	TS411CB	FLIP-TOP 2L COPPER/BLACK	\$39.10	717996130207	30717996130208	1.59	9.20	6
18	TS411KB	FLIP-TOP 2L GOLD/BLACK	\$39.10	717996130283	30717996130284	1.59	9.20	6
18	TS501BL	FLIP-TOP .6L BLACK	\$25.10	717996140015	30717996140016	1.64	6.00	6
18	TS501CB	FLIP-TOP .6L COPPER/BLACK	\$25.10	717996140206	30717996140207	1.64	6.00	6
18	TS501KB	FLIP-TOP .6L GOLD/BLACK	\$25.10	717996140282	30717996140283	1.64	6.00	6
36	TS612AL	TEAPOT 16 OZ ALMOND	\$17.20	717996150700	30717996150701	0.39	3.40	6
36	TS612BL	TEAPOT 16 OZ BLACK	\$17.20	717996150717	30717996150718	0.39	3.40	6
36	TS612BU	TEAPOT 16 OZ BURGUNDY	\$17.20	717996150731	30717996150732	0.39	3.40	6
36	TS612CBT	TEAPOT 16 OZ COLBALT BLUE	\$17.20	717996150748	30717996150749	0.39	3.40	6
36	TS612FG	TEAPOT 16 OZ FOREST GREEN	\$17.20	717996150762	30717996150763	0.39	3.40	6
36	TS612GR	TEAPOT 16 OZ GRAY	\$17.20	717996150779	30717996150770	0.39	3.40	6
36	TS612MV	TEAPOT 16 OZ MAUVE	\$17.20	717996150786	30717996150787	0.39	3.40	6
36	TS612ST/BR	TEAPOT 16 OZ STONEWARE/BROWN	\$17.20	717996150809	30717996150800	0.39	3.40	6
36	TS612ST/BU	TEAPOT 16 OZ STONEWARE/BURGNDY	\$17.20	717996150816	30717996150817	0.39	3.40	6
36	TS612ST/COB	TEAPOT 16 OZ STONE/CNTRY BLUE	\$17.20	717996150823	30717996150824	0.39	3.40	6
36	TS612WH	TEAPOT 16 OZ WHITE	\$17.20	717996150793	30717996150794	0.39	3.40	6
18	TSL1BL	LID FLIP-TOP .6L & 1L BLACK	\$4.50	717996360017	30717996360018	0.26	2.00	12
18	TSL1OR	LID FLIP-TOP .6L & 1L ORANGE	\$4.50	717996360307	30717996360308	0.26	2.00	12
18	TSL2BL	LID FLIP-TOP 2L BLACK	\$4.50	717996370016	30717996370017	0.26	2.04	12
18	TSL2OR	LID FLIP-TOP 2L ORANGE	\$4.50	717996370306	30717996370307	0.26	2.00	12
36	TST612AL	TEAPOT 16 OZ W/TETHER ALMOND	\$17.60	717996150847	30717996150848	0.39	3.40	6
36	TST612BL	TEAPOT 16 OZ W/TETHER BLACK	\$17.60	717996150854	30717996150855	0.39	3.40	6
36	TST612BU	TEAPOT 16 OZ W/TETHER BURGUNDY	\$17.60	717996150878	30717996150879	0.39	3.40	6

PAGE	PRODUCT CODE	PRODUCT DESCRIPTION	2008 LIST EACH PRICE	PRODUCT UPC	CASE UPC	CUBE	CASE WT.	CASE QTY
36	TST612CBT	TEAPOT 16 OZ W/TETHER COBALT	\$17.60	717996150885	30717996150886	0.39	3.40	6
36	TST612FG	TEAPOT 16 OZ W/TETHER FOR GRN	\$17.60	717996150892	30717996150893	0.39	3.40	6
36	TST612GR	TEAPOT 16 OZ W/TETHER GRAY	\$17.60	717996150908	30717996150909	0.39	3.40	6
36	TST612MV	TEAPOT 16 OZ W/TETHER MAUVE	\$17.60	717996150915	30717996150916	0.39	3.40	6
36	TST612QTZ	TEAPOT 16 OZ W/TETHER QUARTZ	\$22.20	717996151097	30717996151098	0.39	3.40	6
36	TST612RUBY	TEAPOT 16 OZ W/TETHER RUBY	\$22.20	717996151080	30717996151081	0.39	3.40	6
36	TST612SPH	TEAPOT 16 OZ W/TETHER SAPHIRE	\$22.20	717996151066	30717996151067	0.39	3.40	6
36	TST612ST/BR	TEAPOT 16 OZ W/TETHER STON/BRN	\$17.60	717996150939	30717996150930	0.39	3.40	6
36	TST612ST/BU	TEAPOT 16 OZ W/TETHER STON/BUR	\$17.60	717996150946	30717996150947	0.39	3.40	6
36	TST612ST/COB	TEAPOT 16 OZ W/TETHER STON/COB	\$17.60	717996150953	30717996150954	0.39	3.40	6
36	TST612WH	TEAPOT 16 OZ W/TETHER WHITE	\$17.60	717996150922	30717996150923	0.39	3.40	6
56	TTONG3W2	2 PK 3-WAY POLY SERVING TONG	\$19.70	717996000906	30717996000907	0.05	0.60	2
57	URN15	URN 1.5 GAL CHROME/GLD	\$940.00	717996260201	30717996260202	2.61	30.40	1
57	URN15GAS	URN LID GASKET 1.5 GAL	\$10.30	717996260263	30717996260264	NA	0.05	1
57	URN15LEG	URN 15 COMPLETE STAND	\$273.00	717996260294	30717996260295	1.21	22.50	2
57	URN15LID	URN LID W/GASKET 1.5 GAL	\$58.00	717996260324	30717996260325	NA	2.00	1
57	URN30	URN 3 GAL CHROME/GOLD	\$1,226.00	717996260218	30717996260219	3.75	35.00	1
57	URN30GAS	URN LID GASKET 3 GAL	\$10.30	717996260270	30717996260271	NA	0.06	1
57	URN30LEG	URN 30 COMPLETE STAND	\$358.00	717996260300	30717996260301	NA	23.50	1
57	URN30LID	URN LID W/GASKET 3 GAL	\$76.00	717996260331	30717996260332	NA	2.50	1
57	URN50	URN 5 GAL CHROME/GOLD	\$1,420.00	717996260225	30717996260226	4.81	43.00	1
57	URN50GAS	URN LID GASKET 5 GAL	\$10.30	717996260287	30717996260288	NA	0.05	1
57	URN50LEG	URN 50 COMPLETE STAND	\$410.00	717996260317	30717996260318	1.91	24.50	2
57	URN50LID	URN LID W/GASKET 5 GAL	\$88.00	717996260348	30717996260349	NA	3.00	1
57	URNSPIG	REPLACEMENT URN SPIGOT	\$78.90	717996260355	30717996260356	NA	0.80	1
57	URNSPIGGW	REPL URN SPIGOT GASKET&WASHER	\$10.00	717996260478	30717996260479	NA	0.20	1
13	WC1	STAINLESS WINE CHILLER	\$31.50	717996433001	30717996433002	1.54	19.60	12
53	WIND	ZEPE PADDLE & HANDLE f/MULINO	\$65.00	717996274338	30717996274339	NA	0.20	1
21	WP15CH	WATER PITCHER 1.5 LITER CHROME	\$86.30	717996215560	30717996215561	2.36	28.20	12
21	WP15SA	WATER PITCHER 1.5 LITER SATIN	\$86.30	717996215577	30717996215578	2.36	28.20	12
21	WP1CH	WATER PITCHER 1 LITER CHROME	\$79.20	717996213283	30717996213284	1.82	24.00	12
21	WP1SA	WATER PITCHER 1 LITER SATIN	\$79.20	717996214570	30717996214571	1.80	24.00	12
21	WP20CH	WATER PITCHER 2 LITER CHROME	\$115.80	717996215591	30717996215592	2.19	27.00	8
21	WP20SA	WATER PITCHER 2 LITER SATIN	\$115.80	717996215607	30717996215608	2.19	27.00	8
21	WP3CH	WATER PITCHER .3 LITER CHROME	\$70.10	717996213580	30717996213581	1.18	17.00	12
21	WP3SA	WATER PITCHER .3 LITER SATIN	\$70.10	717996213597	30717996213598	1.18	17.00	12
21	WP6CH	WATER PITCHER .6 LITER CHROME	\$75.40	717996213320	30717996213321	1.32	18.40	12
21	WP6SA	WATER PITCHER .6 LITER SATIN	\$75.40	717996213573	30717996213574	1.32	18.40	12
38	WPS2	2 LITER WATER PITCHER S/S	\$37.29	717996236749	30717996236740	1.57	10.00	6
38	X7025	WATER PITCHER 64 OZ STAINLESS	\$28.00	717996237173	30717996237174	2.99	19.60	12
53	YOGURT28W	RECT YOGURT 28 CMP WHITE POLY	\$354.20	717996271047	30717996271048	1.12	30.00	1
53	ZEPEBOWL1	BOWL 4.75 F/8070 SERIES DISP	\$24.00	717996270583	30717996270584	NA	NA	1
53	ZEPEBOWL2	BOWL 5-5/8 F/MULINO DISPENSERS	\$24.00	717996270590	30717996270591	NA	NA	1

FOODSERVICE REPRESENTATIVE LOCATIONS

ARIZONA, COLORADO, NEW MEXICO,
EL PASO, TEXAS, UTAH & WYOMING

TRC Marketing

Colorado
303-373-1940
Fax 303-371-1557

Arizona
602-485-0300
Fax 602-485-0220

ARKANSAS, WESTERN TENNESSEE,
LOUISIANA & MISSISSIPPI

Middleton Sales & Marketing
901-382-8444
Fax 901-382-8004

CALIFORNIA, NORTHERN

Access Group
510-567-1000
Fax 510-567-1005

CALIFORNIA, SOUTHERN

Synergy Tabletop
562-947-5295
Fax 562-947-9785

FLORIDA, CARRIBEAN

Maidenberg & Associates
727-531-7189
Fax 727-531-7152

GEORGIA, ALABAMA & EASTERN TENNESSEE

Sara Griggs & Associates, LLC
770-565-0138
Fax 770-578-8304

HAWAII

Pacific Rim Rep Group, Inc.
808-524-8884
Fax 808-524-8817

ILLINOIS, NORTHERN

Casper Marketing Group
847-803-5200
Fax 847-803-5204

LAS VEGAS, NEVADA

AJ Sales, Ltd.
702-243-3192
Fax 702-243-3194

MARYLAND, WASHINGTON D.C.,
VIRGINIA & DELAWARE

T. Furr
410-850-0446
Fax 410-850-5899

MASSACHUSETTS, VERMONT, NEW HAMPSHIRE,
MAINE, RHODE ISLAND & CONNECTICUT

Abramson & DiBenedetto Mktg. Group
508-787-1008
Fax 508-787-1099

MICHIGAN (EXCEPT UPPER MICHIGAN)

dba Mid-West Associates
MW Group, Inc.
419-531-9300
Fax 419-531-9057

MINNESOTA, WISCONSIN, NORTH DAKOTA,
SOUTH DAKOTA & UPPER MICHIGAN

Vlasaty Marketing
763-494-5618
Fax 763-494-9364

MISSOURI, KANSAS, IOWA, NEBRASKA
& SOUTHWEST ILLINOIS

Searles Associates
913-764-5558
Fax 913-764-8668

NEW YORK, METRO; NORTHERN NEW JERSEY

Robert E. Kardos & Associates
516-681-6670
Fax 516-935-6739

NEW YORK, UPSTATE AREA CODES: 315, 518 & 716;
PENNSYLVANIA, WESTERN & WEST VIRGINIA

Robert Emig & Assoc., Inc
412-635-9909
Fax 412-635-9908

NORTH CAROLINA, SOUTH CAROLINA

Food Touch Systems
704-943-9176
Fax 704-943-9175

OHIO, KENTUCKY, INDIANA & SE ILLINOIS

Contemporary F.S. Marketing
216-642-9505
Fax 216-642-9506

PENNSYLVANIA, EASTERN & SOUTHERN
NEW JERSEY

Barsky-Fleming, Inc
215-289-5411
Fax 215-289-5420

TEXAS & OKLAHOMA
(EXCEPT EL PASO)

E Source Hospitality
214-614-0250
Fax 214-614-0251

WASHINGTON, OREGON, ALASKA, IDAHO &
MONTANA

Roller & Associates
206-547-3555
Fax 206-547-8630

WISCONSIN, EASTERN, CENTRAL

Casper Marketing Group
414-964-5775
Fax 414-964-9466

INTERNATIONAL

H.D. Sheldon & Company
212-924-6920 (New York)
305-828-4060 (Miami)
60-3-775-5508 (Malaysia)

CANADA

Plastic Parameters
877-594-0805
Fax 905-944-0990

EUROPE

Versele Global Marketing
+32 (0)9 242 8380 (Belgium)

OCS/COFFEE & VENDING REPRESENTATIVES

Joe Krawczyk
800-328-4493
coffee@serviceideas.com

EASTERN PENNSYLVANIA, MARYLAND, VIRGINIA,
DELAWARE

Veer Resources
610-407-4165
Fax 610-407-0288

HAWAII

Pacific Rim Rep Group, Inc.
808-524-8884
Fax 808-524-8817

ARIZONA, CALIFORNIA, IDAHO, MONTANA,
NEW MEXICO, NEVADA, UTAH, WYOMING

Pacific Brokerage Company
775-787-7946
Fax 775-787-7956

ILLINOIS, INDIANA, MICHIGAN, OHIO & KENTUCKY

Perry & Associates
847-498-4066
Fax 847-919-3920

OREGON/WASHINGTON

Roller & Associates
206-547-3555
Fax 206-547-8630

TEXAS, OKLAHOMA, LOUISIANA

Loftus & Associates
281-496-7660
Fax 281-496-2237

MIDWEST (MN, ND, SD, WI, IA, NE, UP)

Andy Krawczyk
800-491-6052
Fax 651-730-8880

NEW ENGLAND (CONNECTICUT, MAINE,
MASSACHUSETTS, NEW HAMPSHIRE,
RHODE ISLAND & VERMONT)

Pardee, Freeman Inc.
978-281-2700
Fax 978-281-2987

NEW YORK, NEW JERSEY

RepCo
973-875-0049
Fax 973-875-0870

SERVICE IDEAS, INC.

2354 VENTURA DRIVE WOODBURY MINNESOTA 55125
651-730-8800 TEL 800-328-4493 TOLL-FREE 866-905-8880 FAX
WWW.SERVICEIDEAS.COM

TERMS AND CONDITIONS

TERMS

1% 10 days from date on invoice, net 30 days. Accounts showing balances owing past 60 days will be placed on credit hold and charged 1% interest per month. Orders may be paid by MasterCard or Visa at receipt of invoice. Any orders paid by credit card later than 10 days from invoice date may be subject to 3% handling fee.

FREIGHT

Orders totaling 0 - \$149 net will be charged \$10.00 for shipping and handling. Orders totaling \$150 - \$1,200 net will be charged 8% of invoice total for shipping and handling. Single orders that exceed \$1,200 net will be shipped freight prepaid within the United States. Any prepaid or 3rd party shipping is subject to a \$8.00 net handling charge.

BROKEN CASES

All products are sold in standard packing cartons only as listed in the price list. Any order calling for less than standard pack will be charged \$5.00 NET PER CASE.

CREDIT

Orders placed by buyers without established credit with Service Ideas, Inc. must be accompanied by check, credit card or credit application. Initial orders for open credit status must meet a minimum net total of \$500. Orders will ship as soon as possible after credit has been approved or regular check has cleared. Orders paid by cashier's check, MasterCard, Visa, certified check or money order will ship as soon as possible. Call 1-800-328-4493 for exact cash amounts or to request a credit application. We reserve the right to establish or refuse any business entity or individual as a customer.

PRICES

All prices in US dollars (\$) and subject to change without notice.

LOST AND DAMAGED SHIPMENTS

Risk of loss is buyer's upon delivery to carrier; therefore, whenever the seller shall deliver or cause to be delivered to a common carrier any goods ordered by buyer, whether the particular common carrier shall have been designated in the shipping or routing instruction of buyer or not, seller shall not be responsible for any delays or damages in shipment and the common carrier to which the seller shall deliver goods shipped to buyer is hereby declared to be the agent of the buyer. All shortages or damages must be reported within 48 hours to the carrier and Service Ideas. Secure an inspection report from the carrier. Concealed damage not reported to Service Ideas within 30 days of delivery will not be eligible for credit.

RETURNS

By definition, returns are any merchandise sold by Service Ideas, Inc. that is to be returned to the factory. Returns within 6 months of invoice date are NOT SUBJECT TO A RESTOCKING CHARGE. Returns received 6-12 months of invoice date or related to overstock are subject to restocking charges, not to exceed 20%. No returns will be accepted after 12 months. All returns to be restocked must be complete case packs, received in the unopened original cartons and merchandise must be current, standard catalog items. We are unable to accept returns of obsolete, special order, custom or crested products.

No merchandise will be accepted for return without prior authorization. To receive authorizations please call 1-800-328-4493 and provide the following information. All returns must be freight prepaid.

- Company name, address, phone number
- Exact carton count
- Original invoice number and purchase order number
- Reasons for return
- Exact quantity and model numbers

CONVERSIONS

U.S. TO METRIC LINEAR MEASURE

inches	cm	mm
2.125	5.5	55
2.5	6.5	65
2.75	7	70
3.125	8	80
3.5	9	90
4	10	100
4.33	11	110
4.75	12	120
5	12.5	125
5.125	13	130
5.5	14	140
6	15	150
6.33	16	160
6.75	17	170
7	18	180
7.5	19	190
8	20	200
8.25	21	210
8.66	22	220
9	23	230
9.5	24	240
10	25	250
10.25	26	260
10.5	27	270
11	28	280
11.5	29	290
12	30	300
12.25	31	310
12.66	32	320
13.5	34	340
13.75	35	350
14.125	36	360
14.5	37	370
15	38	380
15.33	39	390
15.75	40	400

U.S. TO METRIC VOLUME MEASURE

ounces	liters	gallons
6	0.2	
10	0.3	
13.5	0.4	
16	0.5	
20	0.6	
22	0.65	
24	0.7	
27	0.8	
30.4	0.9	
33.8	1.0	
40.6	1.2	
44	1.3	
50.7	1.5	
54	1.6	
60.8	1.8	
64.2	1.9	
67.6	2.0	
74.4	2.2	
81.1	2.4	
84.5	2.5	
101.4	3.0	
126.8	3.75	
	4.0	1.2
	6.0	1.6
	7.0	1.8
	10.0	2.6
	20.0	5.3

U.S. TO METRIC WEIGHT

1 Ounce = 28.35 Grams
1 Pound = .454 Kilograms

VOLUME

1 Ounce = 2.957 Centiliters
1 Ounce = 296 Milliliters
1 Pint = .473 Litros
1 Liquid Quart = .946 Liters
1 Gallon = .038 Dekaliters

LINEAR MEASUREMENT

1 Inch = 2.54 Centimeters
1 Inch = 25.4 Millimeters

METRIC TO U.S. WEIGHT

1 Gram = .035 Ounces
1 Kilogram = 2.205 Pounds

VOLUME

1 Liter = 1.057 Liquid Quarts
1 Dekaliter = 2.642 Gallons

LINEAR MEASUREMENT

1 Centimeter = .394 Inches
1 Millimeter = .04 Inches

U.S. MEASUREMENTS WEIGHT

16 Ounces = 1 Pound

VOLUME

8 Ounces = 1 Cup
2 Cups = 1 Pint
2 Pints = 1 Quart
4 Quarts = 1 Gallon

SERVING CONVERSION OUNCES TO TEA CUP SERVING SIZE

64 Ounces = 10 Cups
48 Ounces = 8 Cups
32 Ounces = 5 Cups
28 Ounces = 4 to 5 Cups
20 Ounces = 3 Cups
18 Ounces = 3 Cups
16 Ounces = Less than 3 Cups
12 Ounces = 2 Cups
11 Ounces = 2 Cups
10 Ounces = 11/2 Cups
8 Ounces = 1+ Cups

GALLONS TO CUPS

5 Gallons = 80 Cups
3 Gallons = 48 Cups
2 Gallons = 32 Cups
1.5 Gallons = 24 Cups



SERVICE IDEAS, INC.

2354 VENTURA DRIVE WOODBURY MINNESOTA 55125

651-730-8800 TEL 800-328-4493 TOLL-FREE

651-730-8880 FAX 866-905-8880 TOLL-FREE FAX

WWW.SERVICEIDEAS.COM